

# LAVAMAT 50420

Washing machine

Instruction book



## Dear Customer,

Please read this instruction book through carefully, before using the appliance.

Please ensure you fully understand the safety instructions on the first pages of this instruction book! Retain the instruction book for future reference, and pass it on to any future owners.



The warning triangle and/or the key words (**Warning!**, **Caution!**, **Important!**), emphasizes information which is important for your safety or the correct functioning of the appliance. It is essential that this information is observed.

-  **1.** This symbol guides you step by step when operating the appliance.
- 2.** ...



This symbol gives you additional information and practical tips on using the appliance.



Tips and information about the economical and environmentally friendly use of the machine are marked with the clover symbol.

If you require assistance or advice on your appliance, please contact our customer care department by letter or telephone:

Customer Care Department  
AEG Domestic Appliances Limited  
P.O. Box 47  
Newbury  
Berkshire RG 14 5XL  
Tel: 01635 572700  
Fax: 01635 42970

Printed on environmentally friendly paper.  
Whoever thinks ecologically also acts ecologically.

# CONTENTS

<b>Operating Instructions</b> .....	6
<b>Safety Instructions</b> .....	6
<b>Disposal</b> .....	8
<b>Environmental Tips</b> .....	8
<b>Description of the Appliance</b> .....	9
Front View .....	9
Detergent Dispenser Drawer .....	9
Control panel .....	10
Program Selector .....	10
Temperature Selector .....	12
① (ON/OFF) Button .....	12
<b>Consumption Data and Time Required</b> .....	12
<b>Before Using for the First Time</b> .....	13
<b>Preparing a Wash Load</b> .....	13
Sorting and preparing a wash load .....	13
Washing Types and Care Symbols .....	14
Detergents and Conditioners .....	14
Which Detergent? .....	15
And in which form? .....	16
How much Detergent and Fabric Softener? .....	17
Using a Water Softening Agent .....	17
<b>Performing a Washing Cycle</b> .....	18
Brief Instructions .....	18
Loading the Washing .....	19
Adding Detergent/Conditioner .....	19
Setting the Washing Program .....	20
Starting the Washing Program .....	20
Changing the Spin Speed or Selecting Rinse Hold .....	21
During the Washing Program .....	21
Washing Cycle Complete/Removing the Washing .....	22

<b>Program Tables</b> .....	23
Washing .....	23
Washing with a Pre Wash .....	24
Separate Rinsing .....	24
Separate Gentle Rinsing/Starching/Conditioning .....	24
Separate Spinning .....	24
<b>Maintenance and Cleaning</b> .....	25
Control Panel .....	25
Detergent Dispenser Drawer .....	25
Washing Machine Drum .....	25
Door .....	25
<b>What to do when...</b> .....	26
Trouble Shooting .....	26
If the Washing Results are not Satisfactory .....	28
Carrying out an Emergency Emptying .....	29
Cleaning the Drain Pump .....	30
<b>Service &amp; Spare Parts</b> .....	31
<b>Guarantee Conditions</b> .....	32

---

<b>Installation and Connection Instructions</b> .....	34
<b>Installation Safety Precautions</b> .....	34
<b>Appliance Dimensions</b> .....	35
Front and Side Views .....	35
Rear View .....	35
<b>Appliance Installation</b> .....	36
Appliance Transit .....	36
Removing Transit Packaging .....	37
Installation-Site Preparation .....	38
Levelling the Appliance .....	39
<b>Electrical Connection</b> .....	40
<b>Water Connection</b> .....	42
Water Pressure .....	42
Inlet Hose Connection .....	43
Hot and Cold Water Connection .....	44
Water Drainage .....	45
<b>Technical Data</b> .....	46
<b>AEG Service Force</b> .....	46
<b>Index</b> .....	47

# OPERATING INSTRUCTIONS



## Safety Instructions

Your safety is of paramount importance, please ensure you read these warnings before installing or using the appliance. If you are unsure about any of the meanings of these warnings, contact the Customer Care Department.

### Prior to Initial Start-up

- Observe the "**Installation and Connection Instructions**" in this instruction book.
- If the appliance is delivered during the winter and temperatures are below freezing, allow the appliance to stand at room temperature for 24 hours before operation

### Intended Use

- Always unplug the appliance and turn off the water supply after use.
- Only use the washing machine to wash normal domestic washing. If the washing machine is used for any other purpose or is incorrectly used, the manufacturer accepts no liability for any damages which may result.
- It is dangerous to alter the specifications or attempt to modify this product in any way.
- Only use detergents which are suitable for automatic washing machines, and follow the recommendations of the detergent manufacturer.
- Garments which have been in contact with flammable solvents should not be washed.
- Dyes and bleaching agents may only be used if specifically permitted by the manufacturer of these products. We cannot be held liable for any damages.
- Damage due to frost is not covered by the guarantee! If the washing machine is located in a room in which below freezing temperatures might occur, emergency draining must be carried out if danger of freezing occurs (see "Carrying out an emergency emptying"). In addition, the inlet hose must be disconnected from the tap, drained and laid on the floor.

## Child Safety

- This appliance is designed to be operated by adults. Children should not be allowed to tamper with the controls or play with the appliance.
- Pets and children have been known to climb into washing machines. Please check the drum before use.
- Keep all packaging well away from children.
- Keep all detergents in a safe place out of childrens reach.
- When disposing of the appliance, cut off the mains cable, and destroy the plug. Disable the door catch to prevent young children being trapped inside.

## General Safety

- Repairs to the washing machine may only be carried out by qualified personnel. Repairs carried out by inexperienced persons may cause injury or serious malfunctioning. Contact your local AEG Service Force Centre.
- Never operate the washing machine if the mains cable is damaged or the control panel, work top or base area are damaged allowing internal components to be accessible.
- Switch off the appliance and isolate from the mains supply before carrying out any cleaning or maintenance work!
- Do not use the mains cable to pull the plug out of the socket.
- Adaptors and extension cables must not be used. There is risk of overheating!
- During high temperature wash programs, the glass of the door may become hot. Do not touch!
- Allow the water to cool down before cleaning the drain pump or carrying out emergency emptying.



## Disposal

### Packaging

- Dispose of the packaging material correctly. All packaging materials are environmentally friendly and can be disposed of without any danger to the environment.
- The external plastic covering and bags inside are made of polyethylene (marking >PE<).
- The padding is made of CFC free expanded polystyrene (marking >PS<).

### Washing Machine

When disposing of the washing machine:

- Cut off the mains cable and destroy the plug
- Disable the door catch to prevent young children becoming trapped inside.
- Use an authorised disposal site.



## Environmental Tips

To save water, energy and to help protect the environment, we recommend that you follow these tips:

- Do not use a prewash for normally soiled washing.
- It is more economical to wash full loads.
- When washing small loads reduce the detergent by half to two thirds.
- Pre-treat stains, and then wash at a lower temperature.
- Use the energy saving program when washing light to normally soiled garments.



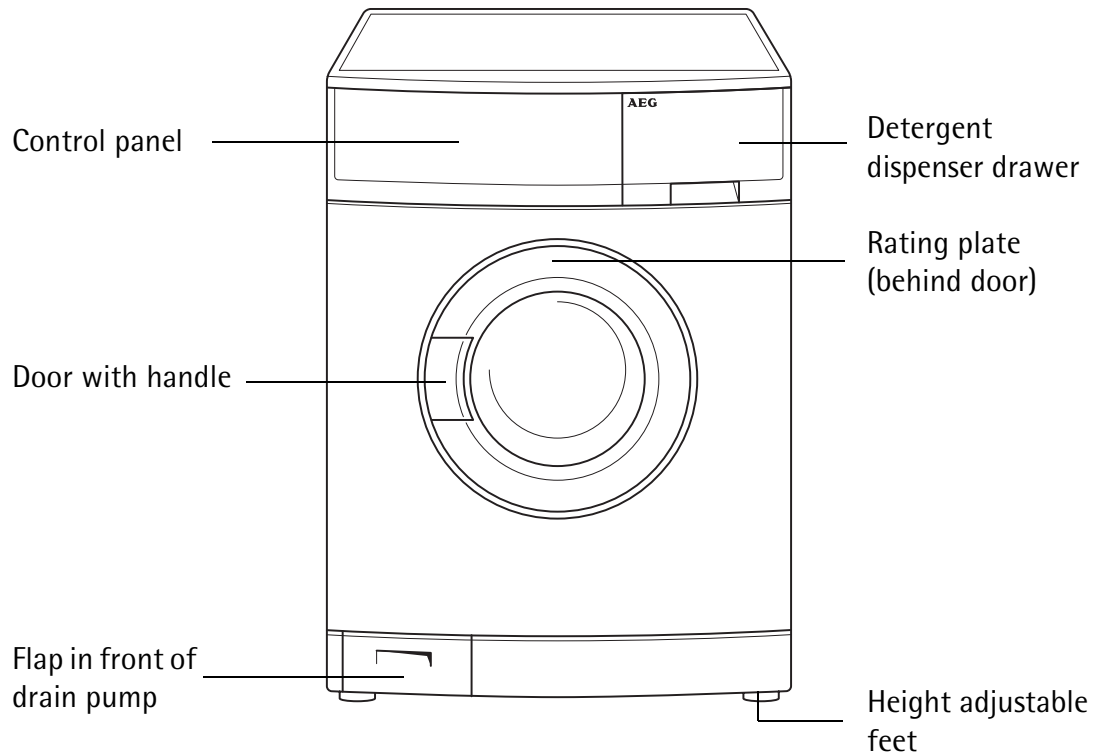

# Description of the Appliance

## Front View



## Detergent Dispenser Drawer

-  Pre wash detergent or stain remover
-  Main wash detergent in powder form and water softening agent if required
-  Liquid conditioners (fabric softener, starch)

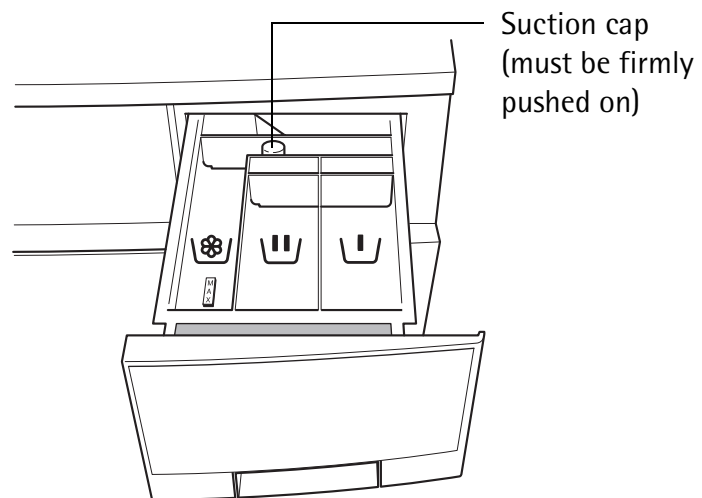

## Control panel

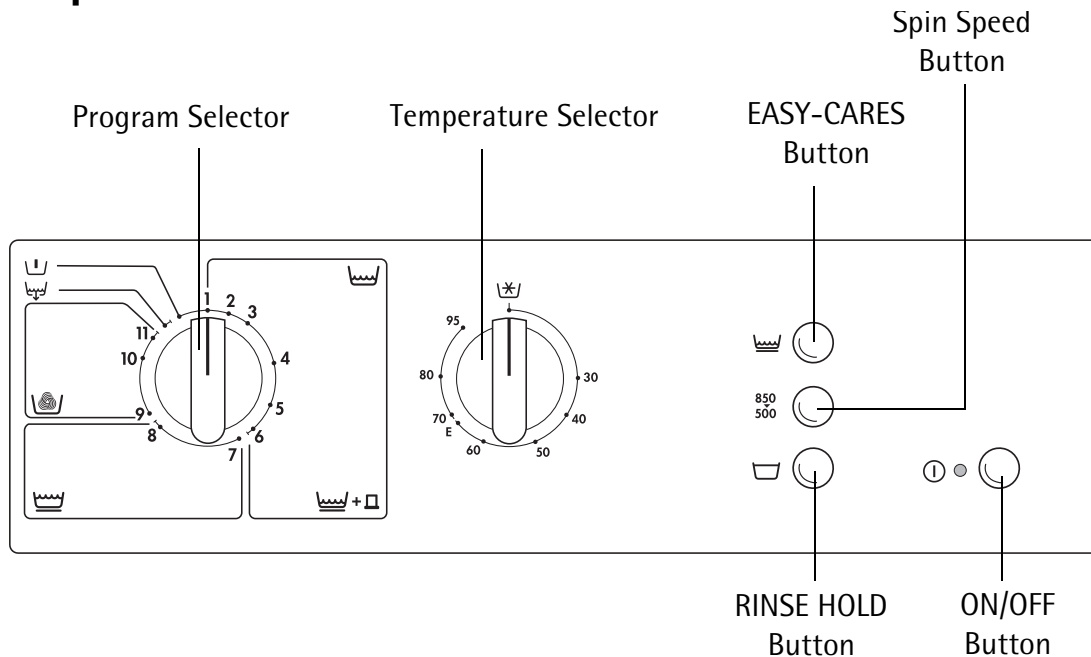

### Program Selector

Select the type of washing cycle using the program selector.

**Important!** Only turn the program selector clockwise!

The various positions have the following effect:

+ COTTONS/LINEN, (EASY-CARES+button) Program Group

(COTTONS/LINEN),

+ (EASY-CARES+button)

**For cottons/linen:** Set the program selector to the desired programme.

**For easy-care washing:** Set the program selector to the desired programme and then also press the (EASY-CARES) button.

- Position 1 (STAIN)

Stain program for treating heavily soiled or stained washing with in-wash stain treatment.

- Position 2 (MAIN WASH)

Main washing cycle for normally soiled washing.

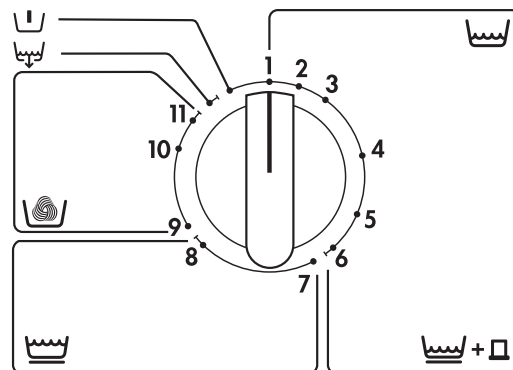

- Position 3 (QUICK WASH)

Shortened main washing cycle for lightly soiled washing.

- Position 4 (RINSE)

Separate rinse, e.g. for rinsing hand washed fabrics (spinning in accordance with the selected washing type or rinse hold).



Rinse hold means: the washing is left in the last rinse water, it is not spun.

- Position 5 (CONDITIONER)

Separate conditioning of cotton/linen or easy-care washing. This setting can also be used for separate starching and separate treatment of cotton/linen or easy-care washing. (1 rinse, liquid conditioner is washed in from the  compartment, spinning as per the programmes for cotton/linen or easy-care washing, or rinse hold.)

- Position 6 (SPIN)

Spinning after a rinse hold or separate spinning of hand washed cotton/linen or easy-care washing.

### (DELICATES) Program Group

- Position 7 (DELICATES)

Main washing cycle for delicates.

- Position 8 (SHORT SPIN)

Spin after a rinse hold, or separate short spin of hand washed delicates.

### (WOOLLENS) Program Group

- Position 9 (WOOL)

Main washing cycle for woollens and particularly delicate fabrics.

- Position 10 (GENTLE RINSE)

Separate short rinse, e.g. for rinsing hand washed fabrics or separate gentle rinsing of delicates or woollens. (1 rinse, liquid conditioner is washed in from the  compartment, short spin or rinse hold.)





- Position 11 (SHORT SPIN)

Spin after a rinse hold, or separate short spin of hand washed woollens or particularly delicate fabrics.

### (PUMP OUT)

Pumps out the water after a rinse hold (without spinning).

### (PRE WASH)

Pre wash (approx. 15 minutes, temperature limited to max. 40 °C) prior to the main washing cycle that follows automatically.  (PRE WASH) can only be combined with  (COTTONS/LINEN) and  +  (EASY-CARES+button).

## Temperature Selector

Using the temperature selector you can select a temperature between  (COLD) and 95° C.



**E Position (Energy Saving):**

Energy saving program at approx. 67° C for lightly to normally soiled cotton washing.

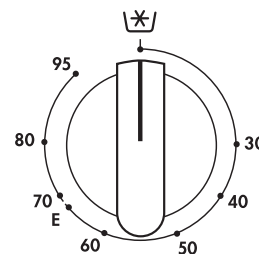

### (ON/OFF) Button

This button is used to switch on the washing machine and start the selected program, or to switch off the washing machine.

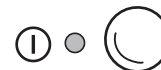

## Consumption Data and Time Required

The values given in the following table for selected programs were calculated under standard conditions. They provide a useful guide for operation in the home.

Program Selector	Button	Temperature Selector	Type of Washing	Load in kg	Water in litres	Cold Water Connection		Hot and Cold Water Connection <sup>1)</sup>	
						Energy in kWh	Time <sup>2)</sup> in min.	Energy in kWh	Time <sup>2)</sup> in min.
Position 2 (MAIN WASH)		95	Cottons	5	59	1.80	119	1.00	119
		60 <sup>3)</sup>	Cottons/ Linen	5	59	1.10	119	0.65	119
		40	Cottons/ Linen	5	59	0.60	119	0.60	119
	 (EASY-CARES)	40	Easy-cares	2,5	48	0.40	86	0.40	86
Position 7 (DELICATES)		30	Delicates	2,5	57	0.45	67	0.45	67
Position 9 (WOOL)		30	Woollens	1	52	0.35	67	0.35	67

1) Figures valid for an inlet water temperature of approx. 60 °C

2) These times are approximate.

3) **Note:** program setting for testing in accordance with EN 60 456

## Before Using for the First Time

1. Pull the detergent dispenser drawer a short distance out of the control panel.
2. Pour about 1 litre of water through the detergent dispenser drawer into the washing machine. When this has been done, the ÖKO lock can function correctly.
3. Run a washing cycle without washing, position 2 (MAIN WASH) 95 °C, with half the amount of washing powder.  
This removes any residues from the drum which may have been left during manufacture.

## Preparing a Wash Load

### Sorting and preparing a wash load

- Sort washing according to care symbol and type (see "Washing types and care symbols").
- Empty all pockets.
- Remove metal objects (paper clips, safety pins etc.).
- In order to prevent bunching up of washing and damage to washing, close zippers, button up duvets and pillow cases, and tie up loose straps such as from aprons.
- Turn articles with double layered textiles inside out (sleeping bags, anoraks etc.).
- Coloured, knitted fabrics, as well as wool and textiles with appliqués should be turned inside out.
- Place small and delicate articles (socks, tights, bras, etc.) into a washing net or a pillow case.
- Handle curtains with care. Remove metal strips or plastic hooks.
- Do not wash coloured and white washing together. White washing will otherwise turn grey.
- New, coloured washing often contains excessive dye. Wash these items separately the first time.
- Mix small and large articles of washing! This improves washing efficiency, and the washing is more evenly distributed during the spin cycle.

- Shake out washing before placing into the washing machine.
- Do not place folded washing into the drum.
- Observe tips such as "wash separately" and "wash separately several times"!

## Washing Types and Care Symbols

Care symbols assist in the selection of the correct washing program. Washing should be sorted according to type and care symbol. The temperatures indicated in the care symbols are maximum temperatures.

### Cottons

Textiles made from cotton and linen with this care symbol will withstand maximum wash actions and high temperatures. The  (COTTONS/LINEN) program is appropriate for this type of washing.

### Linen

Textiles made from cotton and linen with these care symbols will withstand maximum wash actions and high temperatures. The  (COTTONS/LINEN) program is appropriate for this type of washing.

### Easy-care washing



Fabrics such as treated cottons, cotton mixtures and synthetics with this care symbol need a softer washing action. The  (EASY-CARES) program is suitable for this type of washing.

### Delicates

Fabrics such as those with layered fibres, micro-fibres, as well as synthetics and net curtains with this care symbol require particularly careful handling. The  (DELICATES) program is suitable for this type of washing.

### Wool and particularly delicate washing

Textiles such as wool, wool mixtures and silk with these care symbols require a very gentle wash cycle. The  (WOOL) program is appropriate for this type of washing.

**Important!** Fabrics with the the  (Hand Washing) or  (Do Not Wash!) care symbols must not be washed in the washing machine!

## Detergents and Conditioners

Only use detergents and fabric softeners suitable for automatic washing machines. As a general rule follow the instructions of the detergent manufacturers.

## Which Detergent?

To ensure you obtain the best wash results from your appliance, it is important to use the right detergent in your everyday wash, and only detergents recommended for use in automatic machines.

To maintain the appearance of your clothes and household textiles and to make them last longer you should use different types of detergent for different washes whether for whites, colours or delicates.

### Whites

We recommend the Ariel product range which is biological and designed to provide excellent cleaning and stain removal even at lower temperatures.



### Non Biological

If you prefer to use a non biological detergent, which does not contain enzymes we recommend Fairy. Fairy provides good cleaning and stain removal.



### Coloureds

For coloured items, you should use a detergent which is designed to clean while maintaining the original colour. Ariel Color does not contain bleach and therefore helps to preserve colours.



### Delicate Items

When washing delicates, such as wool, you should use a product which is specially designed to care for fine fabrics. Dreft Automatic is suitable for woollens and other delicates.



### Laundry Bleach

For additional stain removal you may wish to use a product such as Ace Gentle Bleach, which is used in addition to your chosen detergent. Ace is suitable for all washable fabrics including coloureds.



## And in which form?

Not only are there different types of detergent, but they are also available in different forms. Whether you choose a powder or liquid in traditional or compact form, is down to personal choice.

### Traditional Powders

Pour the powder directly into the dispenser drawer. Do not sprinkle powder onto clothes in the machine drum.

### Liquids

Measure the detergent into the specially designed dosing device\* which should be placed on top of the laundry, and at the back of the machine drum.

### Compact

Compact detergents (or concentrates as they are also known) are available in liquid or powder form, and generally require a smaller dosage. Follow the manufacturer's instructions to ensure the most economical usage. Pour the detergent directly into the dispenser drawer, or alternatively measure the detergent into the specially designed dosing device\* which should be placed on top of the laundry, and at the back of the machine drum.

**\*If you use a dosing device/ball in a washer dryer, please ensure the device/ball is removed before carrying out a drying programme.**

### Fabric Conditioners

These are ideal for improving „softness“, and also reduce static cling on synthetics and make ironing easier. They are available in two types:

For example Lenor liquid fabric softener, for use in the **washing machine/washer dryer**. The liquid fabric softener should be poured into the compartment marked with the symbol . Follow the manufacturer's dosage instructions and never exceed the MAX level.



Bounce conditioning sheets for use in a **tumble dryer**. We recommend the conditioning sheets are pinned (using a safety pin) to an article of laundry and placed in the tumble dryer.





## How much Detergent and Fabric Softener?

The amount to be used depends on

- the load:



If the detergent manufacturer does not make any specifications for small loads, use a third less for half loads, and for very small loads only use half of the amount of washing powder recommended for a full load.

- the soiling:

For only lightly soiled washing use less washing powder. Follow the instructions of the detergent manufacturer.

- the water hardness:

The harder the water, the higher the dosage! You will find the quantities to use according to water hardness on the detergent packet.



## Using a Water Softening Agent

In hard water areas, the use of a water softening agent can reduce the amount of detergent necessary. See manufacturers recommendations.

# Performing a Washing Cycle

## Brief Instructions

A washing cycle is performed in the following steps:

1. Check whether the water tap is opened.
2. Open the door, load the washing.
3. Close the door.
4. Add detergent/conditioner.
5. Set the correct washing program:
  - Set the program on the program selector;
  - Set the temperature on the temperature selector;
  - In the case of easy-care washing: Press the  (EASY-CARES) button.
6. Press the  (ON/OFF) button.  
The washing machine is switched on. The washing program starts.
7. If necessary, change the spin speed or select rinse hold.  
You can alter this setting and the temperature during the entire washing cycle.

### When the Washing Program has Finished:

**Important!** If the washing cycle ended with rinse hold, carry out a  (PUMP OUT), position 6 (SPIN) or position 8 or 11 (SHORT SPIN) before opening the door.

 For safety reasons, the door remains locked for 1-2 minutes after the end of the program.

8. Open the door, remove the washing.
9. Press the  (ON/OFF) button.  
The washing machine is switched off.
10. Close the water tap.

We recommend you unplug the appliance and turn off the water supply when the washing program has finished.

## Loading the Washing

**i** See "Program Tables" for maximum loads.  
For information about the correct preparation of the washing see "Washing Types and Care Symbols".

- 1.** Sort and prepare washing according to type.
- 2.** Open the door: pull the handle on the door.
- 3.** Load the washing.

**Important!** Do not trap any washing when closing the door! The fabrics and the machine could be damaged!

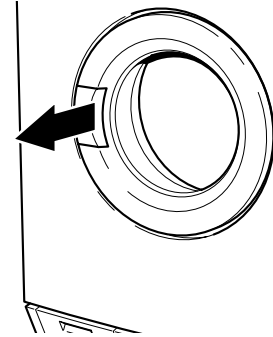

- 4.** Close the door firmly.





## Adding Detergent/Conditioner

**i** For instructions concerning detergents and conditioners see "Detergents and Conditioners".

- 1.** Pull out the detergent dispenser drawer as far as it will go.
- 2.** Add detergent/conditioner.

 Pre-wash detergent or stain remover. Only for  (PRE WASH) and position 1 (STAIN) program.

 Main wash detergent in powder form and water softening agent if used (if you use a water softening agent add the softening agent on top of the main wash detergent.)

 Liquid conditioners (fabric softener, starch)

**Important:** Do not fill above the MAX mark. When using thick concentrated fabric conditioners and starches we recommend you dilute the concentrate with water to ensure trouble-free dispensing. If using starch powder dissolve according to manufacturers instructions.

- 3.** Push the detergent dispenser drawer right in.

### When using Liquid Detergents:

Add liquid detergent with dosing containers provided by the detergent manufacturer. Observe instructions on detergent package.

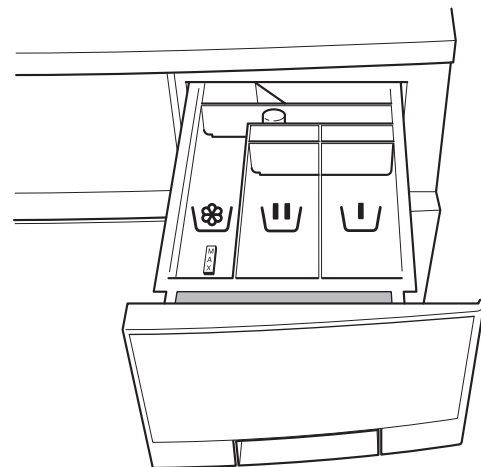

## Setting the Washing Program

**i** Suitable program and the correct temperature for the respective type of washing, see "Program Tables".

**Important!** Only turn the program selector clockwise!

**1.** Set the program selector to the desired washing program.

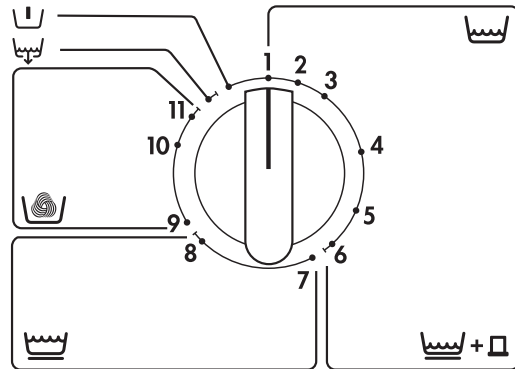

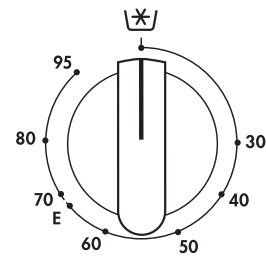

**2.** Set the temperature selector to the desired temperature.



**In the case of easy-care washing:**



**3.** Press the  (EASY-CARES) button.



**i** The  (EASY-CARES) button can only be used with the  (COTTONS/LINEN),  (EASY-CARES+button) programs. If used with any other program it will have no effect.

## Starting the Washing Program

**1.** Check whether the water tap is opened.

**2.** Switch on the washing machine:  
Press the  (ON/OFF) button.  
The  (ON/OFF) indicator illuminates, the washing program starts.



## Changing the Spin Speed or Selecting Rinse Hold

 If desired, reduce the spin speed for the final spin or select rinse hold:

- Press the spin speed button or
- Press the  (RINSE HOLD) button.

If  (RINSE HOLD) is selected, the washing is left in the last rinse water, it is not spun.

850  
500 

 If you do not reduce the spin speed, the final spin for all washing programs is automatically performed at 850 revolutions per minute. The speed for the intermediate spin is dependent on the program selected and cannot be changed.

## During the Washing Program

### Program progress indicator

The program selector serves as a program progress indicator by rotating in a clockwise direction to the end of the program. It is normal for the rotation speed of the program selector to vary during the program.





### Changing settings:

During the washing program you can:

- Change the spin speed
- Select  (RINSE HOLD)
- Change the temperature setting

Other settings cannot be altered.

### Stopping the program early:

-  1. Press the  (ON/OFF) button.
2. Turn the program selector clockwise to  (PUMP OUT), position 6 (SPIN), or position 8 or 11 (SHORT SPIN).
3. Press the  (ON/OFF) button again.
- The water is
- pumped out or
  - pumped out and the washing then spun.

## Washing Cycle Complete/Removing the Washing

The washing program normally ends with the final spin.

### After a rinse hold:

After a rinse hold the water must first be pumped out or the washing spun:

- ✎ 1. Release the (RINSE HOLD) button.
2. Either turn the program selector clockwise to position 6 (SPIN), or position 8 or 11 (SHORT SPIN) (the washing is spun according to the selected program and the spin speed set)  
or  
turn the program selector clockwise to  (PUMP OUT) (the water is pumped out).

### Once the program is finished:

 For safety reasons, the door remains locked for 1-2 minutes after the end of the program.

- ✎ 1. Open the door.
2. Remove the washing.
3. Press the  (ON/OFF) button.  
The indicator extinguishes, the washing machine is switched off.
4. Close the water tap.
5. Pull out the detergent dispenser drawer a little so that it can dry out. Leave the door ajar for a while. This helps to prevent stagnant smells and helps to preserve the door seal.

**Important!** If the washing machine is not to be used for a long period: close the water tap and isolate the washing machine from the mains.

# Program Tables

## Washing

The following tables list the most commonly used and most useful programs.

Type of Washing, Care Symbol	Max. Load (dry weight) <sup>1)</sup>	Program Selector	Temperature Selector	Additional Button
Cottons 	5 kg	Position 1 (STAIN)	70 to 95	
		Position 2 (MAIN WASH)		
		Position 3 (QUICK WASH)		
<b>Energy Saving Program</b> Cottons 	5 kg	Position 1 (STAIN) <sup>2)</sup>	E	
Linen  	5 kg	Position 1 (STAIN)	30 to 60	
		Position 2 (MAIN WASH)		
		Position 3 (QUICK WASH)		
Easy-Cares   	2.5 kg	Position 1 (STAIN)	30 to 60	 (EASY-CARES)
		Position 2 (MAIN WASH)		
		Position 3 (QUICK WASH)		
Delicates 	2.5 kg (or 15-20m <sup>2</sup> net curtains)	Position 7 (DELICATES)	 (COLD) to 40	
Woollens <sup>3)</sup>  	1 kg	Position 9 (WOOL)	 (COLD) to 40	

- 1) A 10 litre bucket contains about 2.5kg of dry washing (cotton).
- 2) It is necessary to extend the time of the Energy Saving Program "E" (67° C) to obtain the same wash results as MAIN WASH (95° C). This is achieved by selecting the STAIN program.
- 3) Woollen clothing with the woollen symbol may only be washed in the machine if they also bear the addition "does not felt", "non-felting" or "washing machine resistant".

## Washing with a Pre Wash

Type of Washing	Max. Load (dry weight)	Program Selector	Temperature Selector	Additional Button
Cottons/Linen	5kg	☐ (PRE WASH)	30 to 95	
Easy-Cares	2.5kg		30 to 60	☐ (EASY-CARES)

## Separate Rinsing

Type of Washing	Max. Load (dry weight)	Program Selector	Additional Button
Cottons/Linen	5kg	Position 4 (RINSE)	
Easy-Cares	2.5kg		☐ (EASY-CARES)
Delicates	2.5kg	Position 10 (GENTLE RINSE)	
Woollens	1 kg		

## Separate Gentle Rinsing/Starching/Conditioning

Type of Washing	Max. Load (dry weight)	Program Selector	Additional Button
Cottons/Linen	5kg	Position 5 (CONDITIONER)	
Easy-Cares	2.5kg		☐ (EASY-CARES)
Delicates	2.5kg	Position 10 (GENTLE RINSE)	
Woollens	1 kg		

## Separate Spinning

Type of Washing	Max. Load (dry weight)	Program Selector	Additional Button
Cottons/Linen	5kg	Position 6 (SPIN)	
Easy-Cares	2.5kg		☐ (EASY-CARES)
Delicates	2.5kg	Position 8 (SHORT SPIN)	
Woollens	1 kg	Position 11 (SHORT SPIN)	



# Maintenance and Cleaning

## Control Panel

**Important!** Do not use household furniture polish or abrasive cleaners to clean the panel and operating parts.

 Wipe over the operating panel with a damp cloth. Use warm water.

## Detergent Dispenser Drawer

The detergent dispenser drawer should be cleaned from time to time.

-  1. Pull the detergent dispenser drawer out as far as it will go.
2. Remove the detergent dispenser drawer by pulling sharply.
3. Remove the suction cap.
4. Clean the suction cap under running water.
5. Clean the separate compartments with warm water. A bottle brush is a useful aid.
6. Push on the suction cap firmly so that it is sitting tightly.
7. Clean the entire compartment area of the washing machine with a brush.
8. Set the detergent dispenser drawer into the guide tracks and push in.

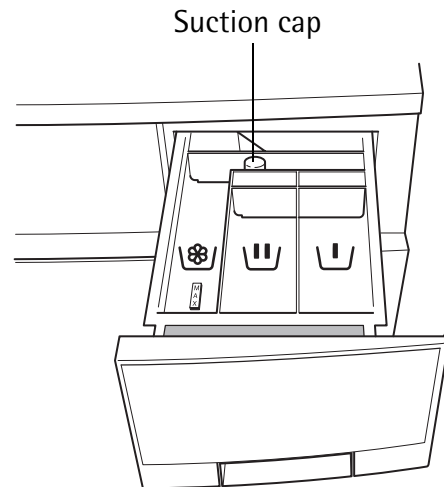

## Washing Machine Drum

The washing machine drum is made from rust-free stainless steel. Any objects left in the laundry which are likely to rust can stain the drum.

**Important!** Do not clean the stainless steel drum with descaling agents containing acids, scouring agents containing chlorine or iron or steel wool. AEG Service Force Centre has suitable agents available. (Part no: 849 646 401 5214).

 Remove rust stains on the drum with a stainless steel cleaning agent.

## Door

 Regularly check if there are deposits or foreign bodies in the rubber seal behind the door and remove them.

## What to do when...



- i** The whistling noise when spinning may be different to your previous washing machine which is due to the modern drive system.



## Trouble Shooting

If you call out an engineer and the fault is listed here, a charge is levied even if the appliance is in guarantee.

Malfunction	Possible Cause	Remedy
Washing machine does not work.	Mains plug is not plugged in.	Insert mains plug.
	House fuse is defective.	Replace fuse or reset.
The machine does not take in water.	Door is not closed properly.	Close door, lock must engage audibly
	Water tap is closed.	Open water tap.
	Filter in the threaded fitting on the water inlet hose is blocked.	Unscrew the hose from the tap, remove the Filter and clean under running water
Washing machine vibrates during operation or is unstable.	The machine is not level.	Adjust the feet according to the installation and connection instruction.
	There is only very little washing in the machine (e.g. only a bath robe).	Does not impair function.
	Water cannot be completely pumped out because the drain hose is kinked or the drain pump is blocked.	Check the drain hose and if necessary remove any kink or clean the drain pump and remove any foreign bodies from the pump housing.
Excessive foaming during the main wash.	Probably too much detergent was used	It may be necessary to reduce the amount of detergent used. Follow the detergent manufacturer's recommendations.

Malfunction	Possible Cause	Remedy
Water runs out from under the washing machine.	Threaded fitting on the water inlet hose is leaking.	Tighten the inlet hose connections.
	The inlet hose has a leak.	Check the inlet hose and if necessary replace it.
	The drain pump cover is not tight.	Tighten cover by turning clockwise.
	Washing is caught in the door.	Stop the program, remove the washing caught in the door, start a new program.
Fabric softener is not added, compartment  for fabric softener is filled with water.	Suction cap in the fabric softener compartment is not correctly fitted or is blocked.	Clean detergent dispenser drawer, place suction cap firmly in position.
Appliance does not spin, water in the drum.	 (RINSE HOLD) selected.	Deselect  (RINSE HOLD).
Washing is not spun properly, water is still visible in the drum.	Drain hose is kinked.	Remove kink.
	Drain hose too high.	Check installation instructions.
	Drain pump is blocked.	Switch off the machine and pull the plug out of the socket, clean the drain pump.
	The water drainage system is blocked.	Clean the blockage.
It is not possible to open the door.	The door is locked for safety reasons.	Wait 1-2 minutes after the end of the program.
Remnants of detergent are building up in the detergent dispenser drawer.	Water tap is not fully open.	Open water tap fully.
	The inlet hose filter in the coupling of the inlet hose at the tap is blocked.	Clean filter.
	The inlet valve filter in the coupling of the inlet hose at the appliance is blocked.	Clean filter.
Rinse water is cloudy.	This is probably due to using a detergent with a high silicate content.	No negative impact on the rinsing results, try using liquid detergent.

## **If the Washing Results are not Satisfactory**

### **If the washing turns greyish and limescale deposits are present in the drum**

- Insufficient washing powder has been added.
- Incorrect washing powder was used.
- Stains were not pretreated.
- Program or temperature was not set correctly.
- When using modular washing powders the individual components were not used in the correct ratio.

### **If there are still grey stains on the washing**

- Washing soiled with ointments, grease or oils was washed with insufficient washing powder.
- The temperature selected for the wash was too low.
- A frequent cause is that fabric softener especially a concentrated one has come into contact with the washing. Wash out these types of stains as fast as possible and use the fabric softener carefully.

### **If after the final rinse foam is still visible**

- Modern washing powders can still cause foam in the final rinse cycle. The washing is nevertheless sufficiently rinsed.

### **If there are white residues on the washing**

- These are insoluble contents of modern washing powders. They are not the result of an insufficient rinse. Shake out the washing or brush it off. Turn the washing inside out before washing it. Review your choice of powder, possibly use liquid detergents.

## Carrying out an Emergency Emptying

- If the washing machine no longer pumps out the water an emergency emptying must be carried out.
- If the washing machine is located in a room in which below freezing temperatures might occur, emergency emptying must be carried out if danger of freezing occurs.  
Furthermore, the inlet hose must be disconnected from the tap, drained and laid on the floor.



**Warning!** Switch the washing machine off and pull the mains plug prior to emergency draining.

**Warning!** The water, which flows out of the emergency emptying hose can be hot. First allow the water to cool down before emergency emptying!

1. Have a flat container on hand to catch the water running out.
2. Pull down the flap in the left corner of the base strip (1) and remove it (2).

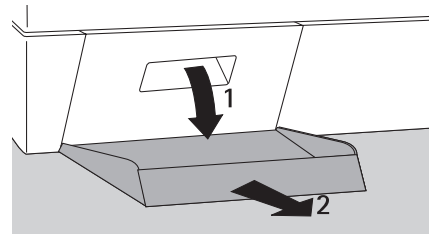

3. Remove the emergency emptying hose from its holder.

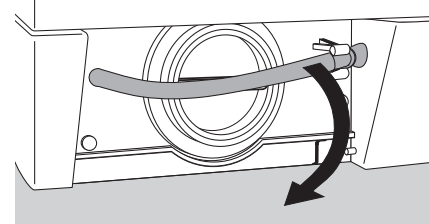

4. Pull the emergency emptying hose out a little.
5. Place the container under the hose.

6. Undo and remove the plug in the end of the emergency emptying hose by turning it anti-clockwise (1) and pull it out (2).  
The wash-water runs out. Depending upon the amount of water, it may be necessary to empty the container several times. Temporarily close the emergency emptying hose with the plug.

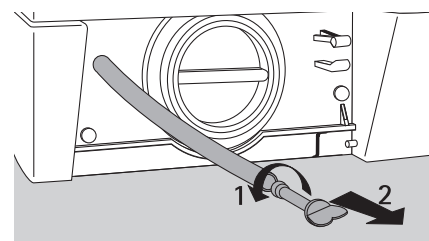

### When the Water is Completely Drained:

7. Push and twist the plug firmly back into the emergency emptying hose.
8. Push the emergency emptying hose back in a little and let it catch on to the holder.
9. Put on the flap and close.

**i** The ÖKO lock does not function when the machine has been fully emptied. Therefore add approx. 1 litre of water before the next wash (pour in through the detergent dispenser drawer).

## Cleaning the Drain Pump

**!** **Warning!** Switch off the washing machine and pull the mains plug out before cleaning the drain pump!

**☞** 1. First carry out an emergency emptying (see section "Carrying out an emergency emptying").

2. Place a towel on the floor in front of the cover of the drain pump. Surplus water may flow out.

3. Unscrew the cover of the drain pump by twisting it anti-clockwise (1) and pull it out (2).

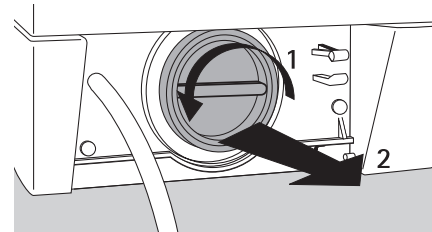

4. Remove any foreign bodies which may be in the pump housing.

5. Check whether the impeller of the pump can be turned. (It is normal for the pump to turn in steps.) If the impeller cannot be turned at all please contact your local AEG Service Force Centre.

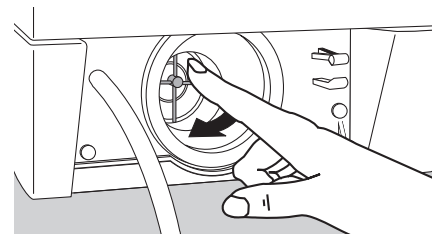

6. Replace the cover (1) (insert the ridges on the cover into the guiding slots) and screw on tightly in a clockwise direction (2).

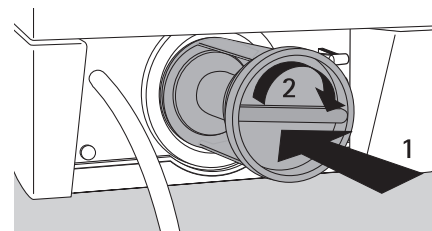

7. Close emergency emptying hose, push in and fix in place.

8. Close the flap.

# SERVICE & SPARE PARTS

If after carrying out the necessary checks there is still a fault with your appliance please contact your local AEG Service Force Centre.

**In guarantee customers should ensure that the suggested checks have been made as the engineer will make a charge if the fault is not a mechanical or electrical breakdown.**

Please note that proof of purchase is required for in-guarantee service calls.

## Service & Spare Parts

If you require a service engineer or wish to purchase spare parts, contact your local AEG Service Force Centre, by telephoning:

**0870 5 929 929**

## Help us to help you

Please determine your type of enquiry before telephoning. When you contact us we need to know.

1. Your name, address and post code.
2. Your telephone number.
3. Clear and concise details of the fault.
  - What is the fault?
  - When does the fault occur?
4. The model, production number and product identification number.
5. Date of purchase.

This information can be found on the rating plate, so you have these numbers to hand we recommend you write them below.

PNC .....

S-No. ....

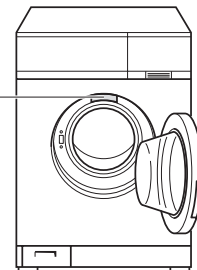
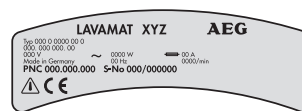

## Customer Care

For general enquiries regarding your AEG appliance, or further information on AEG products please contact our customer care department.

Customer Care Department  
 AEG Domestic Appliances Limited  
 P.O. Box 47, Newbury, Berkshire RG 14 5XL  
 Tel: 01635 572700, Fax: 01635 42970

## GUARANTEE CONDITIONS

### Guarantee Conditions

AEG offer the following guarantee to the first purchaser of this appliance.

1. The guarantee is valid for 12 months commencing when the appliance is handed over to the first retail purchaser, which must be verified by purchase invoice or similar documentation.

The guarantee does not cover commercial use.

2. The guarantee covers all parts or components which fail due to faulty workmanship or faulty materials. The guarantee does not cover appliances where defects or poor performance are due to misuse, accidental damage, neglect, faulty installation, unauthorised modification or attempted repair, commercial use or failure to observe requirements and recommendations set out in the instruction book.

This guarantee does not cover such parts as light bulbs, removable glassware, dust bags or filters.

3. Should guarantee repairs be necessary the purchaser must inform the nearest customer service office (manufacturer's service or authorised agent). AEG reserves the right to stipulate the place of the repair (i. e. the customer's home, place of installation or AEG workshop).
4. The guarantee or free replacement includes both labour and materials.
5. Repairs carried out under guarantee do not extend the guarantee period for the appliance. Parts removed during guarantee repairs become the property of AEG.
6. The purchaser's statutory rights are not affected by this guarantee.



**European Guarantee**

If you should move to another country within Europe then your guarantee moves with you to your new home subject to the following qualifications:

- The guarantee starts from the date you first purchased your product.
- The guarantee is for the same period and to the same extent for labour and parts as exist in the new country of use for this brand or range of products.
- This guarantee relates to you and cannot be transferred to another user.
- Your new home is within the European Community (EC) or European Free Trade Area.
- The product is installed and used in accordance with our instructions and is only used domestically, i. e. a normal household.
- The product is installed taking into account regulations in your new country.

Before you move please contact your nearest Customer Care Centre, listed below, to give them details of your new home. They will then ensure that the local Service Organisation is aware of your move and able to look after you and your appliances.

France	Senlis	+33 (0) 44 62 29 29
Germany	Nürnberg	+49 (0) 911 323 2600
Italy	Pordenone	+39 (0) 1678 47053
Sweden	Stockholm	+46 (0) 8 738 7910
UK	Newbury	+44 (0) 1635 572700

# INSTALLATION AND CONNECTION INSTRUCTIONS

## Installation Safety Precautions

- This appliance is heavy, care should be taken when moving it.
- When moving, do not tip the washing machine onto its front or left hand side (viewed from the front). This is to prevent the possibility of electrical components becoming wet.
- Before installation inspect the machine for transport damage. Do not connect the appliance if it is damaged – contact your retailer.
- Ensure all packaging and transit bolts/bar have been removed, see "Removing of Transit Packaging". Failure to remove packaging and transit bolt/bar may cause serious damage to the product or property.
- Any plumbing work required to install this appliance should be carried out by a qualified plumber or competent person.
- Any electrical work required to install this appliance should be carried out by a qualified electrician or competent person.
- Check the electricity supply is the same as that indicated on the rating plate of the appliance.
- Should the appliance mains cable need to be adapted for any reason this should only be carried out by a qualified/competent person.
- In the case of a permanent connection it is necessary that you install a double pole switch between the appliance and the electricity supply (mains), with a minimum gap of 3 mm between the switch contacts and of a type suitable for the required load in compliance with the electrical regulations.
- The switch must not break the yellow and green earth cable at any point.
- Care must be taken to ensure that the appliance does not stand on the electrical supply cable.
- The installation must comply with local water authority and building regulations requirements.
- Appliances designed for cold water connection must not be connected to hot water.

# Appliance Dimensions

## Front and Side Views

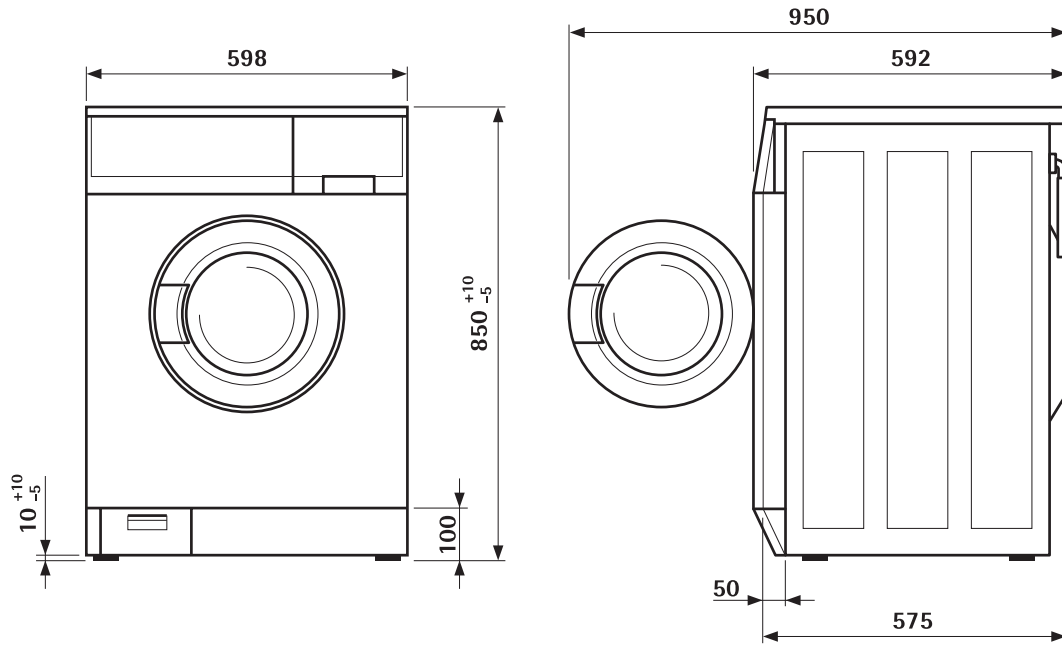

## Rear View

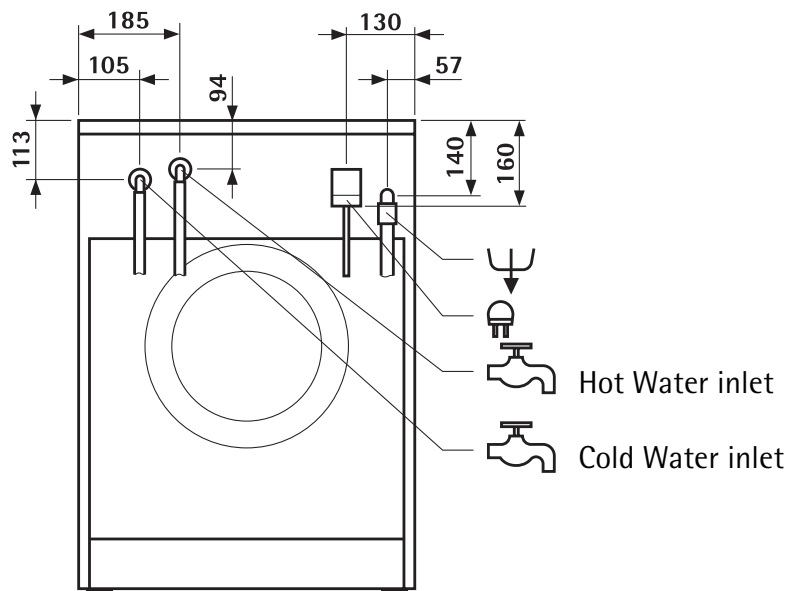

## Appliance Installation



The appliance worktop must not be removed to gain a height reduction when installing under a kitchen worktop.

### Appliance Transit

- To prevent electrical components becoming wet when moving the appliance, do not tip the washing machine onto its front or the left hand side (viewed from the front).
- Do not transport the appliance without the transit packaging/bolts/bar in place. Transporting the appliance without the transport packaging/bolts/bar in place may cause damage to the product.
- Never lift the appliance by the door.
- The appliance is heavy, care must be taken when moving it.

## Removing Transit Packaging

**Important!** Ensure all transit packaging is removed prior to installation. Retain transit packaging for future use.

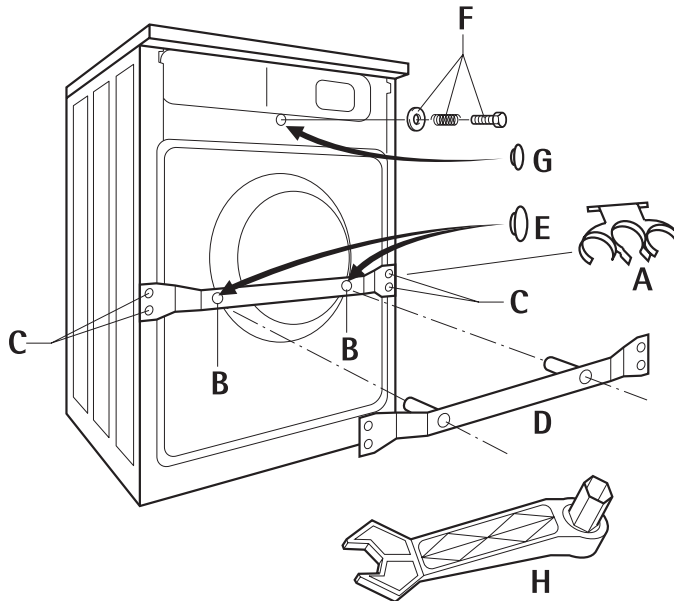

**i** The appliance is supplied with a spanner (H) and plastic caps (E) (2 pcs.) and (G) (1 pc.).

- 1.** Remove the hose holder (A).
- 2.** Remove the 2 screws (B) with the spanner supplied (H).
- 3.** Remove the 4 screws (C).
- 4.** Remove the transit bar (D).
- 5.** Cover the holes left by screws (B) the 2 plastic caps (E).  
**Important:** When fitting the plastic caps, press until they snap into the rear panel securely.
- 6.** Replace the 4 screws (C), for safe keeping.
- 7.** Remove the screw and compression spring (F) with the spanner (H), cover the hole with plastic cap (G).  
**Important:** When fitting the plastic cap, press until they snap into the rear panel securely.

## Installation-Site Preparation

- The installation surface must be clean, dry and level.
- Do not install on deep pile carpet.
- If the appliance is installed next to heat source (e. g. cooking appliance), a heat insulating pad (85 x 57 cm) must be placed between the washing machine and the heat source.
- Do not install the appliance in locations where the temperature may fall below freezing.
- Please ensure that when the appliance is installed it is easily accessible for the engineer in the event of a breakdown.

### Installation on a Suspended Floor

Suspended wooden floors are particularly susceptible to vibration. To help prevent vibration we recommend you place a waterproof wood panel, at least 15 mm thick under the appliance, secured to at least 2 floor beams with screws. If possible install the appliance in one of the corners of the room, where the floor is more stable.

## Levelling the Appliance

Using the four adjustable threaded feet, compensation can be made for unevenness in the floor and the height of the appliance adjusted. The height can be adjusted over the range +10... -5 mm.

To adjust the feet use the special spanner supplied for removing the transport braces.

- ✎ 1. Slide the special key firmly onto the hexagon head of the threaded foot all the way to the stop.
2. Adjust the threaded feet so that the appliance is level and stable. The appliance must not rock across the corners when operating under load.
3. If necessary, check positioning with a spirit level.

**Important!** Never use strips or shims of wood or cardboard etc. to compensate for any unevenness in the floor. Always use the adjustable feet.

## Electrical Connection

Any electrical work required to install this appliance should be carried out by a qualified electrician or competent person.



**WARNING - THIS APPLIANCE MUST BE EARTHED.**  
**The manufacturer declines any liability should these safety measures not be observed.**

Before switching on, make sure the electricity supply voltage is the same as that indicated on the appliance rating plate. The rating plate is located at the top of the rim of the open door.

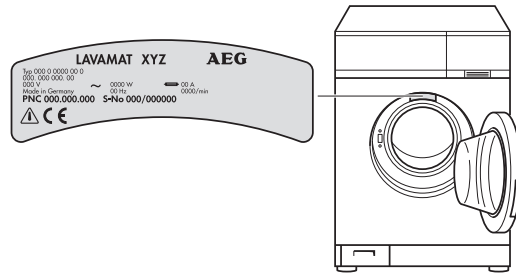

The appliance is supplied with a 13amp plug fitted. In the event of having to change the fuse in the plug supplied, a 13amp ASTA approved (BS 1362) fuse must be used.

Should the plug need to be replaced for any reason. The wires in the mains lead are coloured in accordance with the following code:

Green and Yellow	: Earth
Blue	: Neutral
Brown	: Live

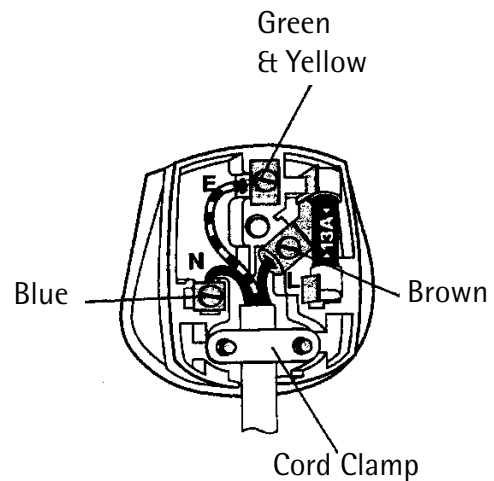

- The wire coloured green and yellow must be connected to the terminal marked with the letter "E" or by the earth symbol  $\oplus$  or coloured green and yellow.
- The wire coloured blue must be connected to the terminal "N" or coloured black.
- The wire coloured brown must be connected to the terminal marked "L" or coloured red.
- Upon completion there must be no cut, or stray strands of wire present and the cord clamp must be secure over the outer sheath.



**WARNING! A cut off plug inserted into a 13 amp socket is a serious safety (shock) hazard. Ensure that the cut off plug is disposed of safely.**



## Permanent Connection

In the case of a permanent connection it is necessary that you install a double pole switch between the appliance and the electricity supply (mains), with a minimum gap of 3 mm between the switch contacts and of a type suitable for the required load in compliance with the current electrical regulations.

The switch must not break the yellow and green earth cable at any point.

- CE** This appliance is in accordance with the following EU Guidelines:
- Low Voltage Guidelines 73/23 EEC dated 19 February 1973, include Guideline Change Notice 93/68 EEC
  - EMC Guideline 89/336 EEC dated 3 May 1989, including Guideline Change Notice 92/31 EEC.

This appliance complies with the requirements laid out in the EEC Directive 76/899.

Voltage 240 V AC                      Fuse rating 13 amps

See rating plate for further information.

This appliance meets VDE requirements.

Particular regulations of local electricity authorities must be observed. This appliance conforms to EEC Directive No. 82/499/EWG on radio interference.



**WARNING!** Repairs to electrical appliances must only be carried out by trained personnel. Improper repairs may lead to serious risks for the user.

## Water Connection



The washing machine is provided with safety devices preventing back-contamination of the water supply and complies with local water authority requirements.

This appliance is designed to be permanently plumbed into your home's water supply.

Before connecting up the machine to new pipework or to pipework that has not been used for some time, run off a reasonable amount of water to flush out any debris that may have collected in the pipes.

## Water Pressure

The appliance is designed to operate within the following water pressure limits:

- minimum 1 bar (14.5 p. s. i.)
- maximum 10 bar (145 p. s. i.)

### **IMPORTANT!**

- At more than 10 bar (145 p. s. i.): Install pressure-reducing valve.
- At less than 1 bar (14.5 p. s. i.): Unscrew the inlet hose from the appliance at the inlet solenoid valve and remove the flow regulator (to do this, remove the sieve with needle-nose pliers and remove rubber washer behind the sieve). Replace sieve. Retain the washer for future use.

## Inlet Hose Connection

The inlet hose provided is 1.2 or 1.3 metres depending on the model. If a longer inlet hose is required contact your AEG Service Force Centre. Under no circumstances should hoses be connected together to provide a longer length.

The rubber washers are either set into the inlet hose threaded connection or supplied separately in the installation kit. These washers must be fitted to ensure water tight seals. Do not use any other washer.

-  **1.** Connect the hose to the machine with the right angled connector.

**Important!** Do not overtighten the plastic nuts on the threaded connectors.

- 2.** Connect the hose end with a straight connector to the water supply tap with an 3/4" thread.

**Important!** Do not overtighten the plastic nuts on the inlet hose threaded connectors.

### **WARNING!**

Open the water taps slowly and check the connections are watertight before final positioning of the machine.

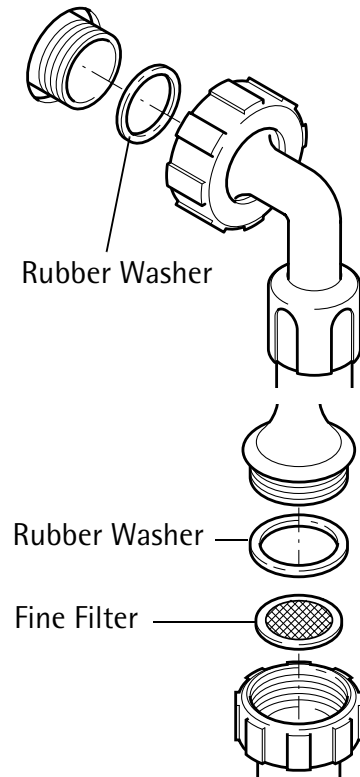

## Hot and Cold Water Connection

Washing machines with hot and cold fill should be connected as shown below.

### **Important!**

The incoming hot water temperature must not exceed 70 °C.

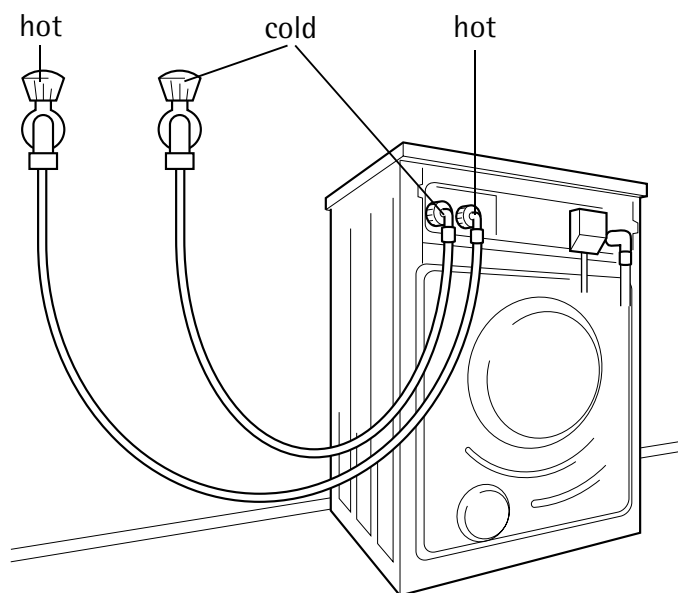

If only a cold water supply is available, connect the two hoses to the cold water outlet by means of a "Y" connection piece.  
(A "Y" piece is available from your AEG Service Force Centre, part number 645.430.709.)

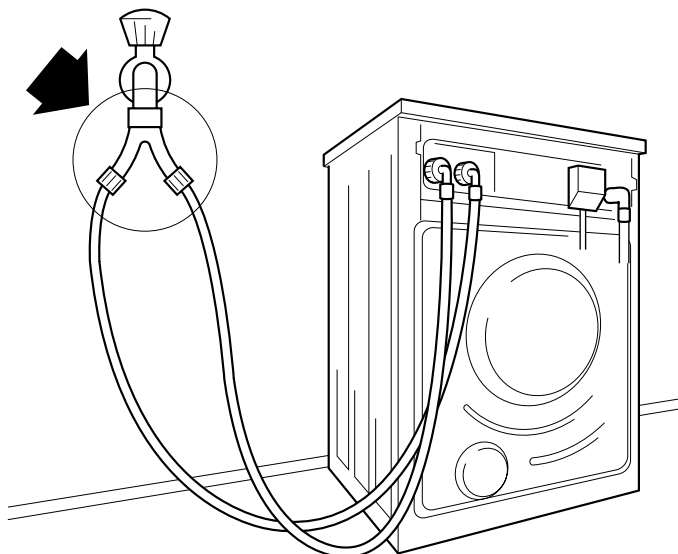

## Water Drainage

The appliance drain hose should hook into a standpipe, the hook in the drain hose is formed using the plastic "U-Piece" supplied. The standpipe should have an internal diameter of approximately 38 mm (see diagram) thus ensuring there is an air break between the drain hose and standpipe.

When discharging into a standpipe ensure that the top of the curve in the hose end is no more than 90 cm (35.4") and no less than 60 cm (23.6") above floor level.

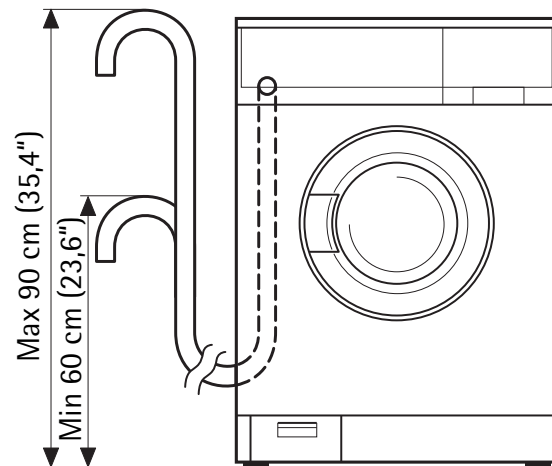

The upright standpipe should have a minimum length of 30 cm (12") from the bottom of the elbow to the top of the pipe (see diagram). Make sure that it is designed in such a way that the end of the drain hose cannot be covered with water. Longer drain hoses are available in lengths of 2.7 and 4 metres from your AEG Service Force Centre.

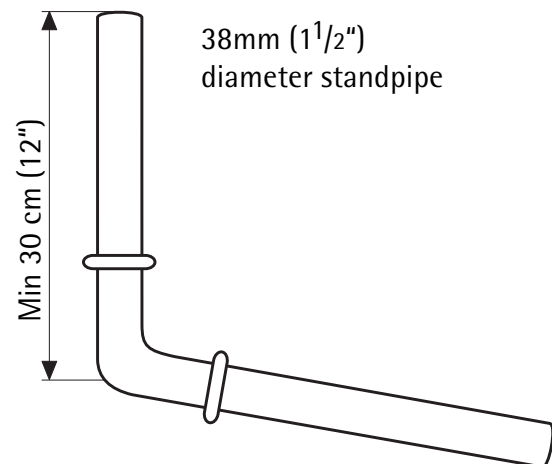

If you intend the drain hose from the washing machine to empty into a sink, make sure that the sink is empty and the plug hose is not blocked. Use the plastic "U-Piece" supplied.

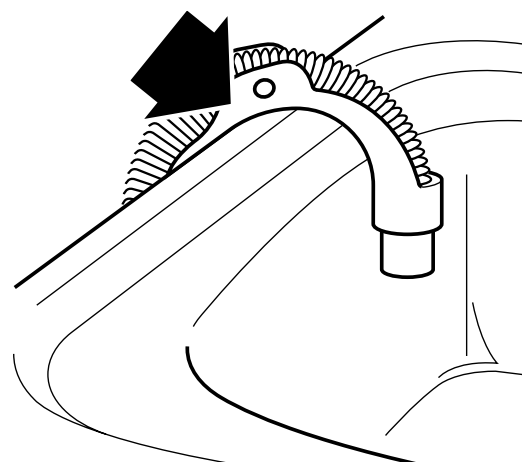

## Technical Data

Height x Width x Depth	85x60x60cm
Depth with open door	95cm
Height adjustment	approx. +10/-5mm
Weight when empty	approx. 85kg
Load (depending on the program)	max. 5kg
Area of use	Household
Wash cycle drum speed	max. 53 min <sup>-1</sup> r.p.m.
Spin cycle drum speed	see rating plate
Water pressure	1-10bar (=10-100N/cm <sup>2</sup> = 0.1 - 1.0MPa)

## AEG Service Force

If you wish to contact your local AEG Service Force Centre for advice or spare parts, telephone:

**0870 5 929 929**

# INDEX

## C

- Conditioner .....11, 14, 16, 19, 24
  - liquid .....9, 19
- Cottons ..... 10, 14, 23, 24
- Customer care ..... 31

## D

- Danger of freezing .....6, 29
- Delicates ..... 11, 14, 23, 24
- Detergent ..... 9, 14, 15, 16, 17, 19
  - liquid .....16, 19
- Door opening ..... 18, 19, 22, 27
- Drain pump .....9, 30

## E

- Easy-Cares .....10, 14, 20, 23, 24
- Energy Saving .....12, 23

## F

- Fabric softener ..... 9, 16, 17, 19

## G

- Gentle Rinse .....11, 24
- Guarantee ..... 6, 26, 32

## H

- Hot/Cold Water Connection ..... 12, 35, 44

## L

- Limescale ..... 28
- Linen ..... 10, 14, 23, 24
- Liquid detergent .....16, 19

## M

- Main Wash .....10, 23

## N

- Net curtains .....14, 23

## O

- ÖKO lock .....13, 30
- Open door ..... 18, 19, 22, 27

## P

- Pre Wash ..... 11, 19, 24
- Program Progress ..... 21
- Pump Out .....11, 22

## Q

- Quick Wash .....11, 23

## R

- Rating plate .....9, 31, 40, 41
- Rinse .....11
- Rinse Hold ..... 10, 11, 21, 22

## S

- Service & Spare Parts .....31
- Short Spin .....11
- Silk .....14
- Spin ..... 10, 11, 21, 24
- Stain ..... 10, 19, 23
- Stains .....8, 9, 28
- Starch ..... 9, 19
- Starching ..... 11, 24
- Stopping the Program .....21

## W

- Washing
  - coloured .....13
  - delicate ..... 13, 14
  - easy-care .....14
  - insufficiently clean .....28
  - lightly soiled .....17
  - normally soiled .....8
  - powder .....16
  - powder residues .....28
- Water
  - hardness .....17
  - pump out ..... 11, 22
  - softening agent ..... 17, 19
- Woollens ..... 11, 14, 23, 24

AEG Hausgeräte GmbH  
Postfach 1036  
D-90327 Nürnberg

<http://www.aeg.hausgeraete.de>

© Copyright by AEG

822 942 096 - 01- 1098