

LAVAMAT 74900

The environmentally friendly washing machine

Instruction booklet



PERFEKT IN FORM UND FUNKTION

AEG

Electrolux

Dear customer,

Please read these operating instructions carefully and pay particular attention to the safety notes indicated in the first pages. We recommend that you keep this instruction booklet for future reference and pass it on to any future owners.



The warning triangle and/or the key words (Warning!, Caution!) emphasize information that is particularly important for your safety or correct functioning of the appliance.



This symbol guides you, step by step, in the operation of the appliance.



The information marked with this symbol provides additional instructions and practical tips on the use of the appliance.



Tips and information about economical and ecological use of the machine are marked with the clover symbol.

Should any problems arise, this booklet provides instructions on how to solve them by yourself; see section "Something not working?".

If this information is not sufficient, please contact our nearest SERVICE CENTRE.

Printed on recycled paper.
People who think ecologically, act accordingly...

Contents

Safety instructions	5-6
Disposal	7
Tips for environmental protection	7-8
Main features of your washing machine	8
Description of the appliance	9
Control panel	10
Programme selector dial	10-12
START/PAUSE button	12
DELAY TIMER button	12
Programme Option buttons	13
SPIN SPEED button	13
RINSE HOLD	13-14
PREWASH	14
STAIN	14
SENSITIVE	14
RINSE+	14
TIME SAVER	15
Display	15
Programme progress display	15
Cancelling a programme	16
Altering a programme which is running	16
Altering an option which is running	16
Opening the door after the programme has started	16
Detergent dispenser drawer	17
Preparing the wash cycle	18
Sorting out and preparing the laundry	18
Weight of laundry	19
Types of fabric and care labels	19
Detergents and additives	21
Which detergent and additive?	21
How much detergent?	21
Liquid detergent	21
Adding a water softener (descaling product)	21
Information on water hardness	21

How to wash	22
Load the laundry	22
Add detergent and additives	22
Select the desired wash programme	22
Select the desired options	23
Select the SPIN SPEED or RINSE HOLD option	23
Select the DELAY TIMER option	23
Starting the programme	24
Programme progress display	24
Display	24
At the end of the programme	25
Programme charts: wash and special programmes	26-28
Cleaning and maintenance	29
After each wash	29
Periodical cleaning	29
Exterior	29
Detergent dispenser drawer	29
Door seal	30
Drain pump	30
Water inlet filter	31
Emergency emptying out	32
Frost precautions	32
Something not working?	33
Troubleshooting	33-35
Unsatisfactory washing results	36
Technical data	37
Service & Spare parts	38-39
Guarantee Conditions	40-41
Instructions for installation and electrical connection	41
Safety instructions for the installer	41
Installation	42
Unpacking	42
Positioning	43
Levelling	43
Water inlet	43-44
Water drainage	44-45
Electrical connection	46-47
Permanent connection	47



Safety instructions

The safety of AEG/ELECTROLUX appliances complies with the industry standards and with legal requirements on the safety of appliances. However, as manufacturers, we feel it is our duty to provide the following safety notes.

General safety

- Repairs to the machine must be carried out only by qualified personnel. Repairs carried out by inexperienced persons could cause serious danger. Contact your local AEG/ELECTROLUX Service Force Centre.
- Never start the machine if the electrical supply cable is damaged or the control panel or worktop are so damaged that inner components can be reached.
- Unplug the appliance before carrying out any cleaning or maintenance operations.
- Never pull the power supply cable to remove the plug from the socket; always take hold of the plug itself.
- Never spray the machine with a jet of water. Danger of electric shock!
- During high temperature wash programmes the door glass may get hot. Do not touch it!
- Let the water cool down before carrying out emergency emptying or before opening the door in an emergency.
- Small animals can gnaw electric wires and water hoses causing electrocution hazard and damage due to water leaks.

Positioning, connection, starting up

- Follow the **instructions for positioning and connection**.
- Carry out a first wash without laundry (COTTONS 95, with half the amount of detergent) in order to remove any manufacturing residue from the tub and the drum.
- Should the machine be purchased in winter, when temperatures can be below 0°, leave the appliance for 24 hours at ambient temperature before starting it.

Child safety

- Children are often not aware of how dangerous electrical appliances can be. When the machine is working, children should be carefully supervised and not be allowed to play with the appliance - there is a risk that they could become trapped inside.
- The packaging components (e.g. plastic film, polystyrene) can be dangerous to children - danger of suffocation! Keep them out of children's reach.
- Keep all detergents in a safe place out of children's reach.
- Make sure that children or pets do not climb into the drum.
- When the appliance is to be scrapped, cut off the electrical supply cable and destroy the plug with the remaining cable. Disable the door catch in order to prevent children from becoming trapped inside while playing.

Proper use

- This appliance is designed for domestic use only. If the machine is used for any other purposes or is not used correctly, the manufacturer accepts no responsibility for any damage that might occur.
- For safety reasons, the appliance must not be modified.
- Use only detergents suitable for washing machines and follow the manufacturer's instructions.
- Garments which have been in contact with flammable solvents should not be machine washed.
- Do not use your machine for dry cleaning.
- Dyes and bleaching agents may only be used if specifically permitted by the manufacturer of these products. We cannot be held responsible for any damage.
- Always unplug the appliance and turn off the water tap after use.



Disposal

Packaging materials

The materials marked with the symbol  are recyclable.

>PE<=polyethylene

>PS<=polystyrene

>PP<=polypropylene

This means that they can be recycled by disposing of them properly in appropriate collection containers.

Machine

Use authorised disposal sites for your old appliance. Help to keep your country tidy!

The symbol  on the product or on its packaging indicates that this product may not be treated as household waste. Instead it shall be handed over to the applicable collection point for the recycling of electrical and electronic equipment. By ensuring this product is disposed of correctly, you will help prevent potential negative consequences for the environment and human health, which could otherwise be caused by inappropriate waste handling of this product. For more detailed information about recycling of this product, please contact your local city office, your household waste disposal service or the shop where you purchased the product.



Tips for environmental protection

To save water, energy and to help protect the environment, we recommend that you follow these tips:

- Normally soiled laundry may be washed without prewashing in order to save detergent, water and time (the environment is protected too!).
- Use the energy saving programmes (ECO) when washing normally soiled garments.
- The machine works more economically if it is fully loaded.
- When small loads are washed, use only half to two thirds of the recommended amount of detergent.
- With adequate pre-treatment, stains and limited soiling can be removed; the laundry can then be washed at a lower temperature.

- If the water has a medium or high degree of hardness (starting from hardness degree II, see "Detergents and additives") water softeners must be added.
The amount of detergent can then be adjusted to hardness degree I (= soft).

Main features of your washing machine

- Programme and temperature setting using the programme selector.
- **STAIN option** for effectively treating stained washing.
- **ENERGY SAVING programme** for normally soiled cotton items.
- **Speed for the final spin** can be reduced to 1000, 700 or 500 rpm.
- **RINSE HOLD**: the laundry is left immersed in the final rinse water to prevent creasing.
- **The programme "40-60 MIX"** can be selected for slightly soiled cotton or mixed fabrics items. The washing performance will achieve the AA class.
- **DELAY TIMER**: programme start can be delayed up to 23 hours (e.g. to times with a more economical power rate).
- **Programme progress display** showing the programme steps selected and the programme phase which is running.
- Because of its gentle washing action, the **special WOOL cycle** washes your garments with extreme care.
- **Programmes LINEN/EASY CARES**: for white/coloured cotton/linen items and delicate mixed fabrics/synthetics. The programme will automatically adapt the type of washing to the different kind of fabrics and loads. In case of washing only of synthetic items, the maximum load will be 4 kg.
- **4-compartment drawer** for detergent, fabric softener and stain-remover.
- **Balance control device**: to prevent vibration during spinning.
- **The new water safety system "AQUA ALARM"** allows you to prevent any flooding due to water leakage.

Description of the appliance

Front view

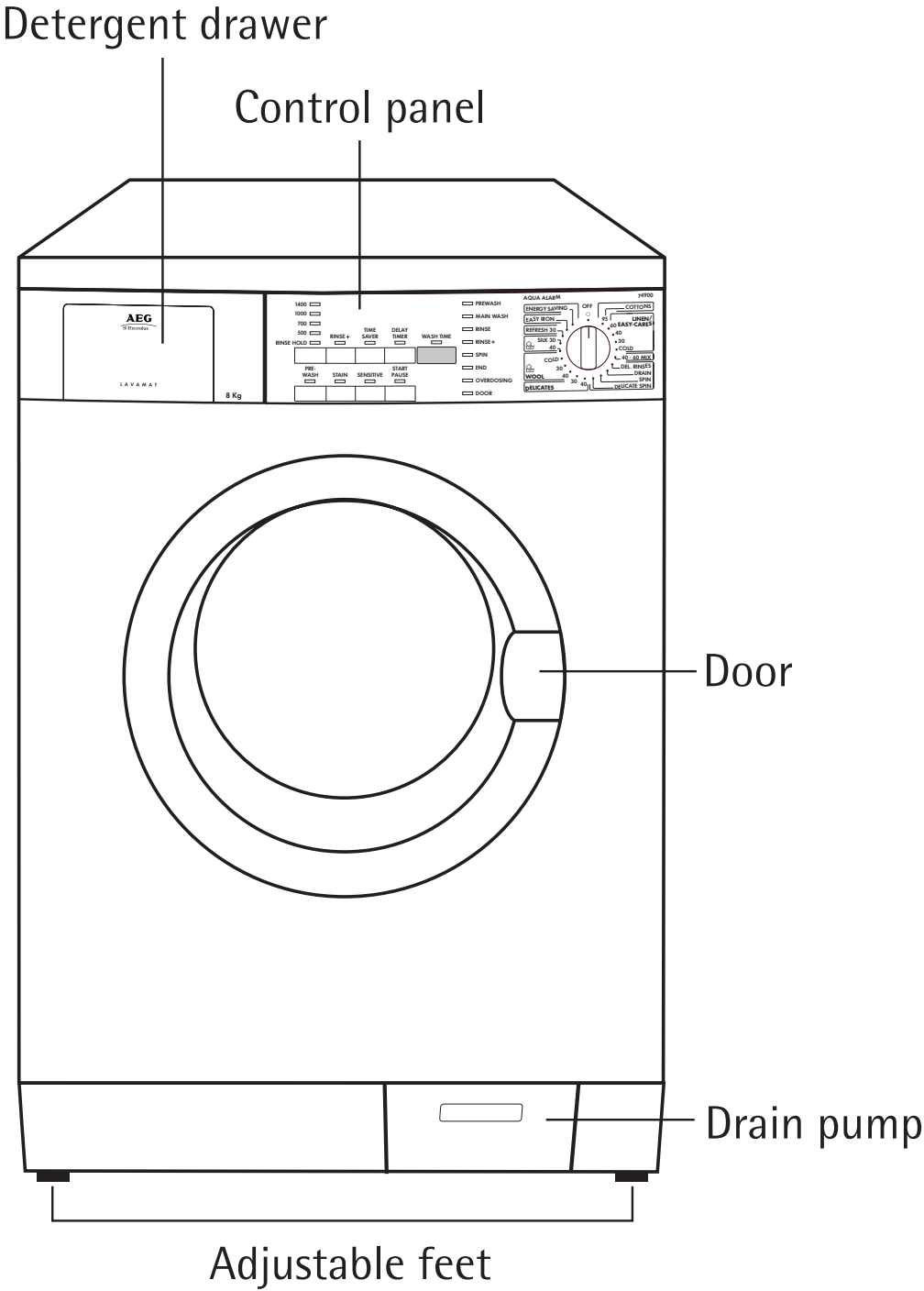

Control panel

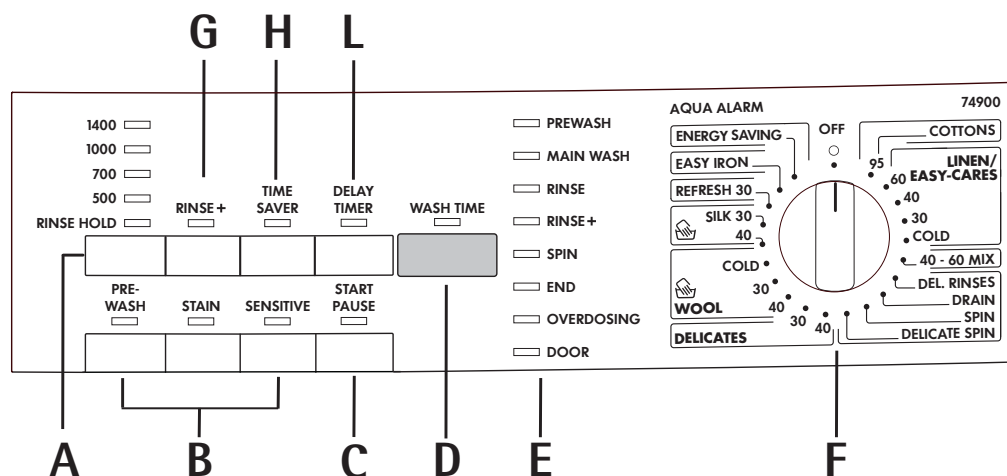

A = SPIN SPEED button

C = START PAUSE button

E = Programme progress display

G = RINSE+ button

L = DELAY TIMER button

B = OPTIONS buttons

D = Display (WASH TIME)



F = Programme selector dial

H = TIME SAVER button

Programme selector dial

The programme selector determines the type of washing cycle (e.g. water level, drum movement, number of rinses) and the washing temperature according to the type of laundry.

The selector dial is divided into the following sections:

- (Withe) COTTONS
- LINEN/EASY CARES
- "40-60 Mix" programme
- Special programmes
- DELICATES
- WOOL / Hand washing 
- SILK 
- Extra programmes (REFRESH 30, EASY IRON and ENERGY SAVING)
- Reset programme **OFF**

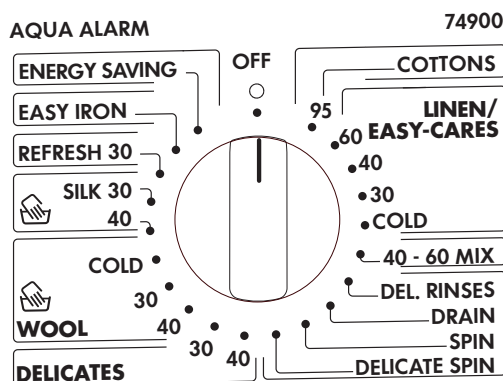

The selector dial can be turned either clockwise or anticlockwise.

COTTONS

Washing programme for white cotton at 95°C (main wash - rinses/softener - long spin).

LINEN/EASY CARES

Washing programme for cotton and synthetics (main wash from 60°C to COLD - rinses/softener - long spin).

40-60 MIX

Washing programme for slightly soiled cotton items or mixed fabrics. It is not compatible with TIME SAVER option.

DELICATE RINSES

Separate cycle of delicate rinses for hand washed items (3 rinses - softener, if needed - short spin)

DRAIN

Drain of the water left in the tub when interrupting a running programme in order to select a new one or at the end of a programme with the RINSE HOLD option.

SPIN

Separate long spin for white and coloured cotton items, that have been washed by hand.

DELICATE SPIN

Separate short spin for delicate items (synthetics, delicate fabrics and wool), handwashed.

DELICATES

Gentle washing programme for delicate items (main wash from 40°C to 30°C - rinses/softener - short spin)

WOOL / HANDWASH  and **SILK** 

Particularly gentle washing for machine washable woolens and silk items to be washed by hand with the label  (handwashing). Main wash from 40°C to COLD (for wool from 40°C to 30°C)- rinses/softener - short spin, reduced intensity of washing cycle).

REFRESH 30

Special programme at about 30°C. Quick wash for sport items, new clothing or items worn once. The programme lasts about 30 minutes.

EASY IRON

With this programme the laundry is gently washed at 40°C and spun to avoid any creasing. In this way ironing is easier. It cannot be combined with SENSITIVE option.

E

Position ENERGY SAVING corresponds to a programme for normally soiled laundry with extended washing time. It cannot be combined with TIME SAVER option.

OFF

Cancellation of the selected programme and switching the machine off.

START PAUSE button

This button has two functions:

a) Start

After having selected the required programme, press this button to start the machine (the corresponding flashing light will become fixe). If you have selected the DELAY TIMER option, the machine starts its hourly countdown.

b) Pause

To interrupt a programme which is running, press the START PAUSE button: the relevant light starts to flash.

To restart the programme from the point at which it was interrupted, **press the START PAUSE button again.**

DELAY TIMER button

The wash programme can be delayed from 30 min – 60 min – 90 min, 2 hours and then by 1 hour up to a maximum of 23 hours by means of this button. This option cannot be selected with DRAIN, SPIN and DELICATE SPIN programmes.

Selecting the delayed start

- Select the programme and the required options.
- Select the delay start.
- Depress START PAUSE button: the machine starts its hourly count down.

The programme will start after the selected delay has expired.

Canceling the delayed start

- Depress START PAUSE button.
- Depress DELAY TIMER button until the the symbol  is displayed.
- Depress START PAUSE button again to restart the machine
- To modify the delay time, after the programme has already started, turn the selector dial to **OFF** (RESET) in order to cancel the current washing programme, set a new programme again and select the new desired delay time.

Programme Option buttons



Depending on the programme, different functions can be combined. These must be selected after choosing the desired programme and before depressing the START PAUSE button.

When these buttons are pressed, the corresponding pilot lights come on. When they are pressed again, the pilot lights go out.

SPIN SPEED

Press this button to reduce the maximum speed of the final speed proposed by the machine for the selected programme or to select option RINSE HOLD. The corresponding light illuminates.

The maximum spin speed for COTTONS, LINEN/EASY CARES programmes, 40-60 MIX, ENERGY SAVING and SPIN programme is 1400 rpm.

For DELICATE SPIN, DELICATES, WOOL  (Hand-wash) /SILK , REFRESH 30 and EASY IRON the spin speed is 1000 rpm.

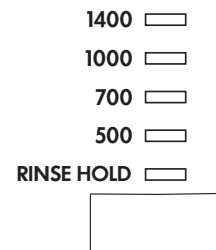

RINSE HOLD

By selecting this option, the last rinse water is not emptied out, to prevent the fabrics from creasing.

When the programme has finished, the START PAUSE button goes off, the END pilot light and the DOOR light (in red) on the programme progress display remain alight, the display shows a static  and the door is locked to indicate that the water must be emptied out.

To empty out water there are two possibilities:



- Select programme DRAIN:
The water is emptied out without spinning.
- Select programme SPIN or DELICATE SPIN. Select the spin speed by

means of the relevant button and then depress the START PAUSE button. The water is emptied out and the laundry is spun at the selected spin speed.

Warning! The programme selector dial must be turned first to **OFF** (RESET) and then to the DRAIN programme or SPIN or DELICATE SPIN.



PREWASH

The machine performs a prewash cycle at 30°C before the main wash. The prewash cycle ends with a short spin in programmes for COTTONS and LINEN/EASY CARES, and with emptying of the water without spinning for DELICATES.

This option is **not** available with the WOOL  (Handwash)/SILK  and REFRESH 30. programmes.

To be used for heavily soiled laundry.

STAIN



To treat heavily soiled or stained laundry with stain remover (extended main wash with time optimised stain action phase). This option is **not** selectable for WOOL  (Handwash)/SILK  or programmes with temperatures lower than 40°C.

SENSITIVE

If you depress this button, the washing machine adds one rinse in COTTONS and LINEN/EASY CARES programmes and reduces the spinning of the drum and the washing intensity. To be used for non fast delicate colours or repeated washing.

This option **cannot be** selected with the EASY IRON programme.

RINSE+

This option can be selected with all programmes, except the WOOL  (Handwash)/SILK  programmes and REFRESH 30.

The machine will add 2 rinses for COTTONS, LINEN/EASY CARES and 1 rinse for "DELICATES".

This option is recommended for people who are allergic to detergents, and in areas where the water is very soft.

Important! If you depress simultaneously the RINSE + and SPIN buttons for about 4 seconds the acoustic signal will be deactivated at the end of the cycle, while selecting a programme or in case of an incorrect option selection. By pressing these buttons again the acoustic signal is reactivated.

TIMER SAVER

By pressing this button the washing time is reduced with COTTONS, LINEN/EASY CARES and DELICATES programmes. For use when washing lightly soiled laundry.

This option is **not available** with **40-60 MIX** and **ENERGY SAVING** programmes.

Display (WASH TIME)

The display shows the following information:

- **Duration of the selected programme (in minutes)**, calculated automatically on the basis of the maximum recommended load for each type of fabric.
- When the programme has finished, a **flashing zero** is displayed.
- When a programme with RINSE HOLD option has finished, a **steadily lit zero** is displayed.
- **Delay start**, (23 hours max.) programmed using the button DELAY TIMER. The countdown is updated every hour during the first two hours and then every thirty minutes.
- **Wrong option selection**. When selecting a programme if you choose an option not compatible with the programme the **Err** code appears on the display.
- **Alarm code** indicating a fault in the machine operation (see page 78).

Programme progress display

By selecting the wash programme, the pilot lights corresponding to the various phases making up the programme come on.

After the machine has started, only the running phase pilot light stays on. When the programme has finished, the END pilot light comes on.



When the programme has finished, if the OVERDOSING light comes on, it indicates that too much detergent has been used.

- PREWASH
- MAIN WASH
- RINSE
- RINSE +
- SPIN
- END
- OVERDOSING
- DOOR

Canceling a programme

To cancel a programme which is running, turn the programme selector dial to the **OFF** (RESET) position.

Warning! After canceling a programme, please check if there is water left in the drum, otherwise turn the selector dial first to **OFF** (RESET), then select the programme DRAIN and then press the **START PAUSE** button.

Changing a programme which is running

To modify the selected programme turn the programme selector dial to **OFF** and then choose a new programme.

The water is **not** emptied out and after pressing the **START PAUSE** button again the machine restarts with the newly selected programme.

Changing an option which is running

To alter an option, first set the machine to **PAUSE** by pressing the **START PAUSE** button.

Any option can be modified before the machine starts it. After selecting the new option press the **START PAUSE** button again to re-start the selected programme.

To modify the selected programme turn the programme selector dial to **O** and then choose a new programme.

The water is **not** emptied out and after pressing the **START PAUSE** button again the machine restarts with the newly selected programme.

Opening the door after the programme has started

To open the door set the machine to **PAUSE** by pressing the **START PAUSE** button.

The door can be opened if:

- the machine is not already heating;
- the water level is not above the bottom edge of the door;





The light **DOOR** on the control panel indicates if the door can be opened:

- green light: the door can be opened;
- red light: the door cannot be opened;

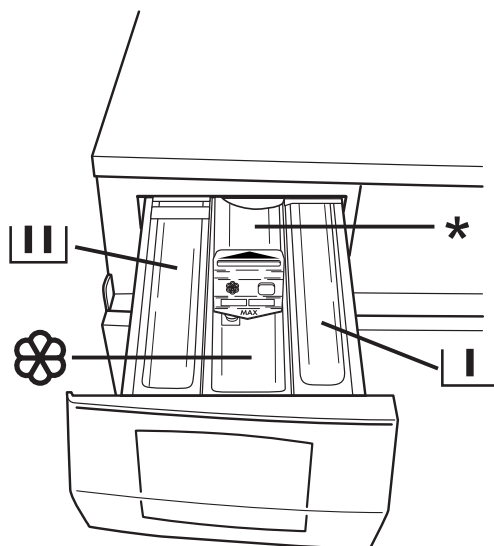
If you cannot open the door, but you need to open it you have to switch the machine off by turning the selector dial to **OFF**. After about 3 minutes the door can be opened (**pay attention to the water level and temperature!**).

Detergent dispenser drawer



-  Compartment for prewash detergent and stain remover. The prewash detergent is added at the beginning of the wash programme. The stain remover is added during the STAIN-Action phase in the main wash.
-  Compartment for powder or liquid detergent used for main wash. It is emptied at the beginning of the wash cycle.
-  Compartment for liquid additives (fabric softener, starch). It is emptied at the last rinse.
The quantity of additives must not exceed the "MAX" mark in the drawer.
-  Compartment for Stain Remover. The stain remover is added during the STAIN-Action phase during the main wash.

Before the first wash

-  Run a cotton cycle at 95° (COTTONS), **without any laundry in the machine**, to remove any manufacturing residue from the drum and tub.
Pour 1/2 a measure of detergent into the dispenser drawer and start the machine.

Preparing the wash cycle

Sorting out and preparing the laundry

- Sort out the laundry according to type of fabrics and care labels (see "Types of fabric and care labels").
- Empty pockets.
- Remove any metal parts (safety pins, clips, etc.).
- To prevent the laundry from getting damaged and forming bundles, it is advisable to close zips, button up pillowcases and quilt covers and tie up loose straps such as those of aprons.
- Turn double faced items inside out (sleeping bags, anoraks, etc.)
- Turn coloured knitted fabrics, woollens and fabrics with trim inside out.
- Wash small and delicate items (baby socks, tights) inside a laundry net or in a pillow case closed with a zip, or in larger socks.
- Treat curtains with special care. Remove all metal or plastic hooks or put them in a net or a bag. We take no responsibility for any damage.
- Whites and coloureds must be washed separately: white items can lose their whiteness.
- New coloured fabrics often have excess dyes; it is advisable to wash them separately for the first time.
- Wash small and large items together; this improves the washing result and the laundry is better distributed during spinning.
- Shake out garments before putting them into the machine.
- Insert each garment separately.

Weight of laundry

Sort of laundry	Approximate dry weights
Bathrobes	1200 g
Work shirts	300-600 g
Quilt covers	700 g
Sheets	500 g
Blouses	100 g
Hand towels	200 g
Tea towels	100 g
Shirts	200 g
Pillowcases	200 g
Night-gowns/Pyjamas	200-250 g
Tablecloths	200-300 g
Underwear	250 g

Types of fabric and care labels

The labels on garments help you to select the most suitable wash programme. The laundry should be sorted out according to the type of fabric and the instructions indicated on care labels.

Temperatures indicated on labels are always maximum temperatures.

Cotton

Linen and cottons marked with this symbol can be washed at high temperatures.

Cotton

Linen and cottons marked with this symbol are colourfast and can be washed at 60°C.

Cotton

Garments marked with these symbols have delicate colours, therefore the washing temperature must not exceed these values.

Synthetics

Mixed and synthetic fabrics marked with these symbols require a gentle wash programme and they must therefore be washed using the specific programme.

Delicates  

Microfibres, synthetics or curtains marked with these symbols require a very gentle treatment.

The DELICATES programme is suitable for this type of fabric.

Woollens and particularly delicate items    

Fabrics such as wool, wool mix or silk marked with this symbol are particularly sensitive to machine washing.

The WOOL programme  is suitable for this type of fabric.

If the label has the symbol  (do not wash), the garments must not be machine washed!

Detergents and additives

Which detergent and additive?

Use only detergents and additives for washing machines. Follow the manufacturer's instructions.

How much detergent?

The quantity depends on:

- the load:
if the manufacturer does not provide any indications on the amount of detergent for small loads, use about one third less than the suggested amount for half loads and half the amount for very small loads;
- the degree of soil:
use a small amount of detergent for lightly soiled garments. Judge the amount according to the detergent manufacturer's instructions and size of the load;
- the water hardness:
the harder the water, the more detergent required. Instructions according to water hardness are given on the detergent pack.

Liquid detergent

Liquid detergent can be poured directly into the main wash compartment of the dispenser drawer **immediately** before starting the programme, or a special dispenser can be used that is placed directly in the drum. Measure the detergent according to the manufacturer's instructions.

Adding a water softener (descaling product)

A water softener must be added when water has a medium-high degree of hardness (from degree of hardness II). Follow the manufacturer's instructions. The quantity of detergent can then always be adjusted to degree of hardness I (= soft). Information on water hardness can be obtained from your local water supply authority.

Information on water hardness

Degree of hardness	German degrees °dH	French degrees °TH
I=Soft	0-7	0-15
II=Medium	7-14	16-25
III=Hard	15-21	26-37
IV=Very hard	more than 21	more than 37

i How to wash

Load the laundry

- ☞ Open the door.
- ☞ Place the laundry in the drum, one item at a time. Distribute laundry as evenly as possible. Close the door.

Add detergent and additives



- ☞ Pull the drawer out till it stops.
- ☞ Pour the main wash detergent into compartment .

If you wish to perform a PREWASH pour detergent into compartment . If you wish to perform a STAIN pour the Stain

Remover into compartment .

Important!

Do not use normal detergent for the STAIN-Action programme, always use a STAIN remover.

- ☞ Pour the fabric softener into compartment  and the bleaching agent into compartment  without exceeding the "MAX" mark.
- ☞ Close the drawer gently, pushing it fully in.

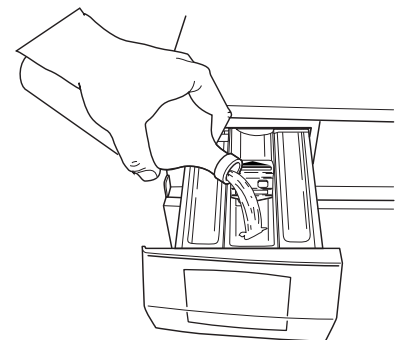
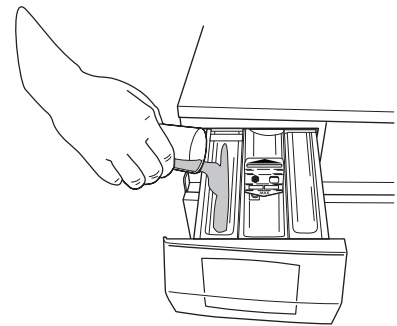

Select the desired wash programme

- ☞ Turn the programme selector dial to the desired position: the lights corresponding to the different phases making up the selected programme light on.

The display shows the duration of the programme in minutes.

- PREWASH
- MAIN WASH
- RINSE
- RINSE+
- SPIN
- END
- OVERDOSING
- DOOR

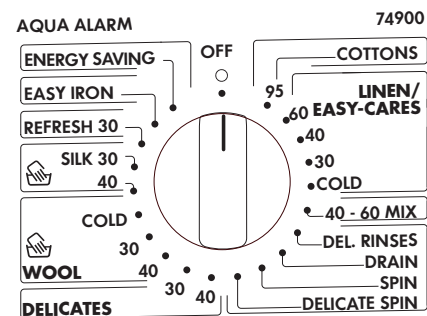

Select the desired options

depending on the degree of soil of the laundry.
The corresponding light comes on.

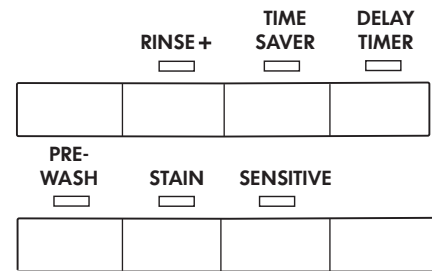

Select the spin speed or RINSE HOLD option

It is possible to select a lower spin speed by means of the relevant button; the light corresponding to the selected speed comes on.

Selecting the option RINSE HOLD the laundry is left immersed in the final rinse water.

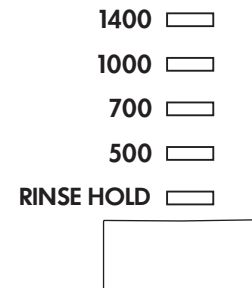

If the spin speed is not reduced, the final spin speed will be as follows:

- COTTONS 1400 r.p.m.
- LINEN/EASY CARES 1400 r.p.m.
- EASY IRON 1000 r.p.m.
- REFRESH 30 1000 r.p.m.
- DELICATES 1000 r.p.m.
- WOOL (hand washing) 1000 r.p.m.
- /SILK 1000 r.p.m.

Select the DELAY TIMER option

To delay starting of a programme, press the DELAY START button **before starting the machine.**

The figures corresponding to the selected delay will be displayed for about 3 seconds, after which the duration of the selected programme will appear on the display.

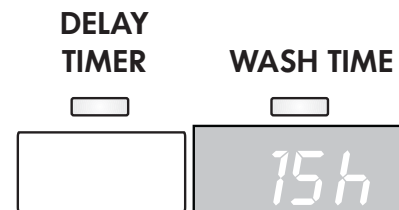

When the START PAUSE button is pressed, the selected delay will appear again on the display and the machine starts its countdown.

Starting the programme

1. Check that the water tap is opened and the drain hose is correctly connected.
2. Press START PAUSE to start the programme. The corresponding light stops flashing and only the pilot light of the running phase will stay on
If the Delay Start option has been selected the programme will start at the end of the countdown.

i If the light END flashes and on the display appears the alarm code *E40* at the start of the programme, it indicates that the door is open. Close firmly the door and press the START PAUSE button again.

If the delay start option has been selected, the machine starts its countdown, in hours for the first two hours and then every 30 minutes, which will appear on the display. During this period it is possible to load other laundry, or to cancel the delay time.

- **Load other laundry:** press the START PAUSE button. Open the door. Load the laundry. Close the door and press the START PAUSE button again.
- **Cancel the delay time:** press the START PAUSE button. Press the DELAY TIMER button until the symbol  appears on the display. Press the START PAUSE button again if you wish to restart the programme.

Programme progress display

By selecting the wash programme, the pilot lights corresponding to the various phases making up the programme come on. After the machine has started, only the running phase pilot light stays on.

- PREWASH
- MAIN WASH
- RINSE
- RINSE+
- SPIN
- END
- OVERDOSING
- DRAIN

Display

By selecting the wash programme, the display shows the duration of the selected programme. After having pressed the START PAUSE button, the time to the end of the programme decreases minute by minute and it appears on the display. If the laundry load is smaller on the display appears the duration of a maximum laundry load.



At the end of the programme

The machine stops automatically. A steadily zero appears on the display. The END light comes on in the programme progress display and the START PAUSE pilot light has gone out.



If the RINSE HOLD option has been selected, the light DOOR will be red and the DOOR will be locked to indicate that the water must be emptied out. The display will show a static zero.

To empty out water there are two possibilities:

- Select programme **DRAIN**: the water is emptied out without spinning.
- Select programme **SPIN** or **DELICATE SPIN**. Select the spin speed by means of the relevant button and then depress the START PAUSE button. The water is emptied out and the laundry is spun at the selected spin speed.

Warning! The programme selector dial must be turned first to **OFF (RESET)** and then to the **DRAIN** programme **SPIN** or **DELICATE SPIN**.



Turn the selector dial to **OFF** to switch the machine off.



Remove the laundry from the drum.



Check that the drum is empty so as to avoid any forgotten items being damaged in a subsequent wash (e.g. shrinking) or their colour running into a load of whites.



Close the water tap.



Leave the door open to prevent the formation of mildew and unpleasant smells.

Programme chart

Wash programmes for cottons, mixed and synthetics

Wash programme	Temp.	Fabrics	Additional functions	Max. load	Consumption*	
					Energy kWh	Water lt.
COTTONS and Linens	95°	White Cotton and linen, for ex. normally soiled work garments, sheets, household linen, underwear, towels.	PREWASH, STAIN, SENSITIVE, TIME SAVER RINSE+, SPIN RED./ RINSE HOLD	8 kg	2.9	75
ENERGY SAVING Cottons	(●)60°	Whites and fast-coloureds.	PREWASH, STAIN SENSITIVE RINSE+ SPEED RED./ RINSE HOLD	8 kg	1.36	60
LINEN / EASY CARES	60°- 40°- 30°- COLD	Coloured cotton or linen fabric, shirts, underwear, towels.	PREWASH, STAIN ** SENSITIVE RINSE+ SPIN RED./ RINSE HOLD	8/4 kg	1.2	65
40-60 MIX	40°	Synthetic fabrics, underwear, coloured garments, non-shrink shirts, blouses.	PREWASH, STAIN SENSITIVE RINSE+ SPIN RED./ RINSE HOLD	8 kg	1.2	65
EASY IRON	40°	Synthetic fabrics, underwear, coloured garments, blouses.	PREWASH, STAIN RINSE+ TIME SAVER SPIN RED./ RINSE HOLD	2 kg	0.55	63



(●) In compliance with EC directive 92/75, the consumption figures indicated on the energy label refer to the **ENERGY SAVING** wash programme for cotton.

* The consumption data shown on this chart is to be considered purely indicative, as it may vary depending on the quantity and type of laundry, on the inlet water temperature and on the ambient temperature. It refers to the highest temperature for each wash programme.

** Only at 40° or higher.

Programme chart

Wash programmes for delicates, wool and silk

Wash programme	Temp.	Fabrics	Additional functions	Max. load	Consumption*	
					Energy kWh	Water lt.
DELICATES	40°-30°	Delicate fabrics, for example curtains.	PREWASH, STAIN** RINSE+ TIME SAVER SPIN RED./ RINSE HOLD	3.5 kg	0.6	65
WOOL  Hand wash	40°-30° COLD	Wool, wool mixtures bearing the "Pure new wool, non-shrink, machine washable" label 	SPIN RED./ RINSE HOLD	2 kg	0.45	65
SILK 	40°-30° COLD	Silk items	SPIN RED./ RINSE HOLD	1 kg	0.3	75

* The consumption data shown on this chart is to be considered purely indicative, as it may vary depending on the quantity and type of laundry, on the inlet water temperature and on the ambient temperature. It refers to the highest temperature for each wash programme.

** Only at 40° or higher.

Programme chart

Special programmes

Programme	Description	Programme phases	Additional functions	Max. load	Consumption*	
					Energy kWh	Water lt.
DELICATE RINSES	This programme can be used for rinsing hand washed garments	3 rinses with liquid additive. Short spin (max. 1000 r.p.m.)	SPIN RED. / RINSE HOLD	8 kg	0.04	60
DRAIN	For emptying out the last rinse water in programmes with the RINSE HOLD option	The water is emptied out.		/	-	-
SPIN	Separate spin for cottons	Long spin.	SPIN RED.	8/4 kg	-	-
DELICATE SPIN	Separate spin for synthetics, delicate fabrics and wool	Short spin. (max. 1000 r.p.m.)	SPIN RED.	3.5 kg	-	-
REFRESH 30	Quick washing cycle for lightly soiled items	Wash at 30° 2 rinses Short spin.	SPIN RED.	3.5 kg	0.35	52
OFF (Reset)		For cancelling the programme which is running or to switch the machine off.				

* The consumption data shown on this chart is to be considered purely indicative, as it may vary depending on the quantity and type of laundry, on the inlet water temperature and on the ambient temperature.

Cleaning and maintenance

After each wash

- ☞ At the end of the wash programme, pull the dispenser drawer out a little to let it dry.
- ☞ Leave the door ajar to allow air to circulate.

If the machine is not used for a prolonged period:

- ☞ Close the water tap and unplug the appliance.

Periodical cleaning

Exterior

- ☞ Clean the outside of the cabinet with soap and water only. Rinse with clean water and dry.
Important: do not use methylated spirits, solvents or similar products to clean the cabinet.

Detergent dispenser drawer

After a while, detergents and fabric softeners leave deposits in the drawer.

- ☞ Clean the drawer, from time to time, by rinsing it under a running tap. To remove the drawer from the machine, press the button in the rear left-hand corner.
- ☞ To facilitate cleaning, the top part of the additive compartments can be removed.
- ☞ Detergent can also accumulate inside the drawer recess: clean it with an old toothbrush.
- ☞ Refit the drawer after cleaning.

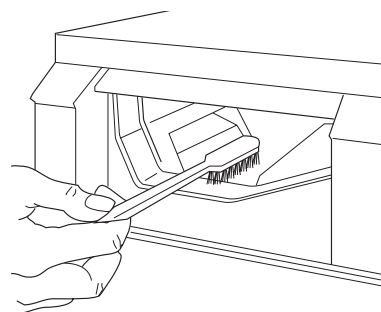
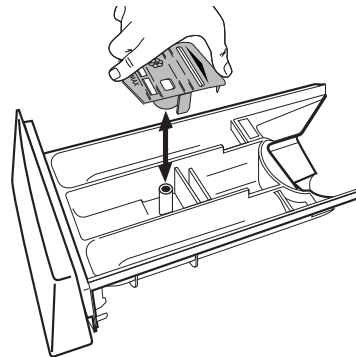

Door seal

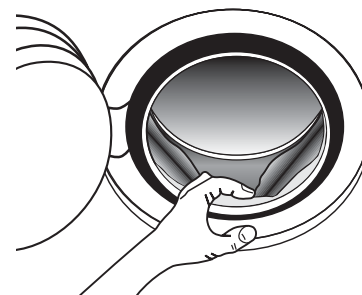

Check from time to time the door seal and eliminate eventual possible objects that could be trapped in the fold.





Drain pump

The pump should be inspected regularly and particularly if the machine does not empty and/or spin the machine makes an unusual noise during draining due to objects such as safety pins, coins etc. blocking the pump.

Proceed as follows:

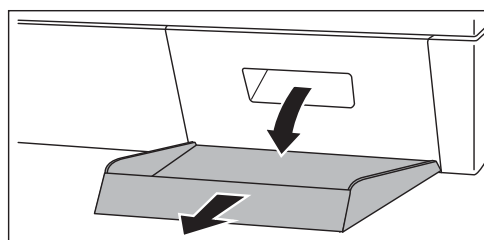
-  Disconnect the appliance.
-  If necessary wait until the water has cooled down.



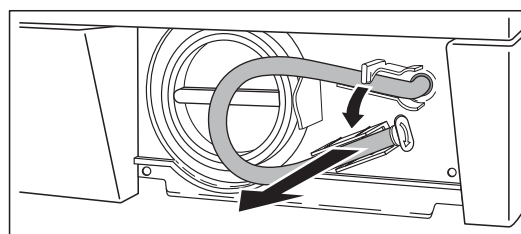

-  Open the pump door.

-  Place a container close to the pump to collect any spillage.

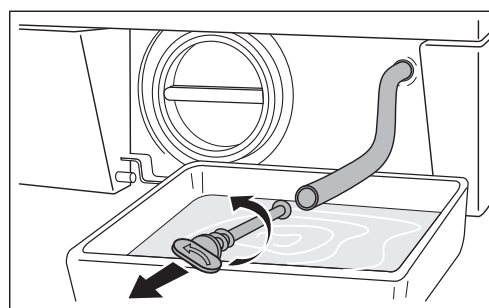

-  Release the emergency emptying hose, place it in the container and remove its cap.



-  When no more water comes out, unscrew the pump and remove it. Always keep a rag nearby to dry up spillage of water when removing the pump.

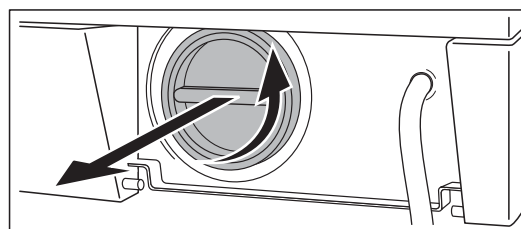

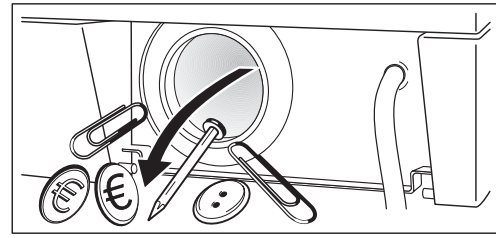

 Remove any objects from the pump impeller by rotating it.

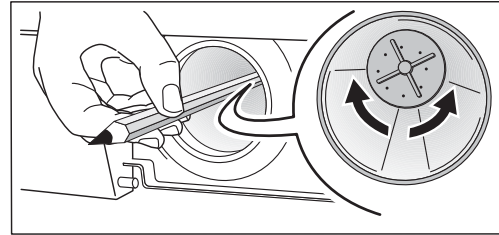

 Put the cap back on the emergency emptying hose and place the latter back in its seat.



 Screw the pump fully in.

 Close the pump door.

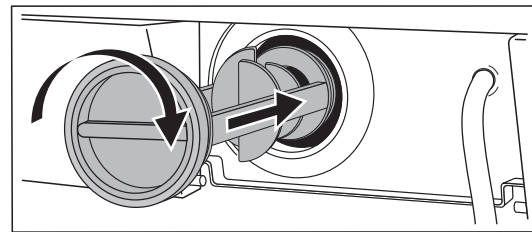

Water inlet filter

If you notice that the machine is taking longer to fill, check that the filter in the water inlet hose is not blocked.

 Turn off the water tap.

 Unscrew the hose from the tap.





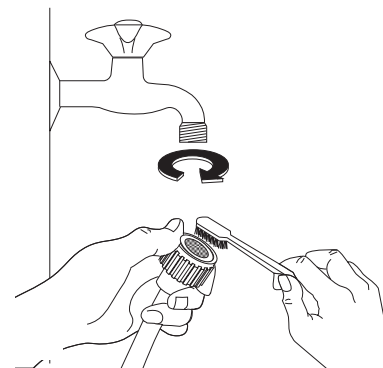



 Clean the filter in the hose with a stiff brush.

 Screw the hose back onto the tap.





Emergency emptying out

If the water is not discharged, proceed as follows to empty out the machine:

-  pull out the plug from the power socket;
-  close the water tap;
-  if necessary, wait until the water has cooled down;
-  open the the pump door;
-  place a bowl on the floor and place the end of the emergency emptying hose into the bowl. Remove its cap. The water should drain by gravity into the bowl. Whe the bowl is full, put the cap back on the hose. Empty the bowl. Repeat the procedure until water stops flowing out;
-  clean the pump if necessary as previously described;
-  replace the emergency emptying hose in its seat after having plugged it;
-  screw the pump again and close the door.

Frost precautions

If the machine is installed in a place where the temperature could drop below 0°C, proceed as follows:

-  Close the water tap and unscrew the water inlet hose from the tap.
-  Place the end of the emergency emptying hose and that of the inlet hose in a bowl placed on the floor and let water drain out.
-  Screw the water inlet hose back on and reposition the emergency emptying hose after having put the cap on again.

By doing this, any water remaining in the machine is removed, avoiding ice forming and consequently damage to the appliance.

When you use the machine again, make sure that the ambient temperature is above 0°C.

Something not working?

i If during the spin cycle the machine makes an unusual whistling noise, different from the noise made by traditional washing machines, this is due to a new type of motor.



If water is not visible in the drum, this is due to the modern technology of new washing machines that use less water than traditional machines.

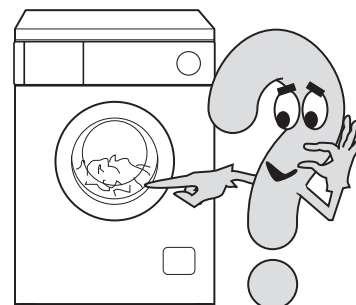

Troubleshooting

If a problem arises, you can try to solve it yourself following the instructions below.

If you call out an engineer when one of the following problems arises, or to repair a fault due to incorrect use, the call-out will be charged even if requested within the guarantee period.

During machine operation it is possible that an acoustic warning signal sounds, the END light blinks and the following alarm codes may be displayed:

- **E10**: problem with the water supply
- **E20**: problem with water draining
- **E40**: door open
- **EFD**: the water safety system (AQUA ALARM) is running.

Once the problem has been eliminated, press the START PAUSE button to restart the programme. If after all checks, the problem persists, contact your local AEG/ELECTROLUX Service Force Centre.

Problem	Possible cause	Solution
The machine does not work	The main electrical fuse has blown.	Replace the fuse.
	The door is not properly closed (E40).	Close the door; the click of the lock should be heard.
	The plug is not connected.	Insert the plug.
	The START PAUSE button has not been pressed.	Press the button.
	The DELAY TIMER option has been selected.	Check the selected delay on the display.

Problem	Possible cause	Solution
The machine does not fill	The water tap is closed (E10) .	Open the water tap.
	The water inlet hose is squashed or kinked (E10) .	Check the whole length of the hose and remove the kink.
	The small filter of the water inlet hose is clogged (E10) .	Clean the filter.
	The door is not properly closed (E40) .	Close the door.
The machine fills then empties immediately	The end of the drain hose is too low.	Place the hose at the right height (see Installation section).
The machine does not empty and/or does not spin	The drain hose is squashed or kinked (E20) .	Check the whole length of the hose and remove the kink.
	The drain pump or the drain hose are clogged (E20) .	Clean the pump or check the hose.
	The RINSE HOLD option (stop with water in drum) has been selected.	Empty out the water by selecting the DRAIN, SPIN or DELICATE SPIN programmes.
	The laundry is not evenly distributed inside the drum.	Redistribute the laundry manually in the drum.
There is water on the floor	Too much detergent has been used.	Measure detergent according to the manufacturer's instructions.
	An unsuitable detergent has been used that creates too much foam.	Use a suitable washing machine detergent.
	One of the connectors on the water inlet hose is leaking.	Check that the hose is firmly screwed on at both ends.
	The drain pump has not been properly screwed on after cleaning.	Fully screw the pump into place.
	The cap on the emergency emptying hose has not been replaced after cleaning the pump.	Replace the cap on the emergency emptying hose after cleaning the pump.
The display shows the alarm code <i>EFO</i>	The water safety system starts working to prevent any flooding.	Switch the machine off, close the inlet pipe, and call the Service Force Centre

Problem	Possible cause	Solution
The machine vibrates or is noisy	The transit bolts have not been removed.	Check that the machine has been unpacked as described in the Installation section.
	The feet have not been adjusted.	Carefully level the machine.
	There is little laundry in the drum.	Correct operation of the machine is not affected.
The door will not open	The programme is still running and the drum is turning.	Wait until the end of the programme before opening the door.
	The water level is above the bottom edge of the door.	Before opening the door, the water must be emptied out.
	The machine is heating the water.	Wait until the end of the heating phase.
Spinning starts late or the machine does not spin	The unbalance detection device that prevents excessive vibration during spinning has cut in.	<p>If the laundry is not evenly distributed inside the drum at the beginning of the spin cycle, the machine detects this and tries to redistribute it more evenly by means of a few drum rotations.</p> <p>Only when the laundry is more evenly distributed will the spin cycle be performed, at a lower speed, if the laundry is not evenly distributed.</p> <p>If, after about 10 minutes, the laundry is still tangled, the machine will not spin. Therefore, if the laundry is still wet at the end of the cycle, it is advisable to redistribute it manually inside the drum and to select the spin programme.</p>

Unsatisfactory washing results

If the laundry looks grey and lime scale is found in the drum

- Too little detergent has been used.
- An unsuitable detergent has been used.
- Stubborn stains have not been treated prior to washing.
- The programme/temperature has not been correctly selected.

If grey stains remain on the laundry

- Laundry stained with ointments, grease or oil has been washed with an insufficient amount of detergent.
- The temperature selected for the wash programme was too low.
- Fabric softener - especially the concentrated type - has come into direct contact with the laundry. Wash these stains immediately and pour fabric softener carefully.

Foam is still visible even after the last rinse

- Modern detergents often produce foam, even in the last rinse. However the laundry has been completely rinsed.

White residue is left on the laundry

- This is due to insoluble components in modern detergents and is therefore not the result of insufficient rinsing. Shake or brush the laundry. In future, it may be better to turn garments inside out before washing them. Check the choice of detergent; try using liquid detergents.

Technical data

Height x Width x Depth	85x60x63 cm
Height adjustment	± 10 mm approx.
Load (depending on programme)	8 kg max.
Use	domestic
Drum speed during washing	max. 55 rpm
Drum speed during spinning	1400/1000/700/500 rpm
Water pressure	0.05 - 0.8 MPa

- CE** This appliance complies with the following EC directives:
- 73/23/EEC of 19.2.1973 "Low voltage directive", including directive 93 / 68 / EEC
 - 89/336/EEC of 3.5.1989 "Electromagnetic Compatibility Directive".

Service & Spare Parts

If after carrying out the necessary checks there is still a fault with your appliance please contact your local AEG/ELECTROLUX Service Force Centre.

In guarantee customers should ensure that the suggested checks in the "Troubleshooting" section have been made as the engineer will make a charge if the fault is not a mechanical or electrical breakdown.

Please note that proof of purchase is required for in-guarantee service calls.

Service & Spare Parts

To buy accessories, consumables and spare parts at our online shop please visit:
<http://www.aeg-electrolux.co.uk>

If you require a service engineer or wish to purchase spare parts, contact your local AEG/ELECTROLUX Service Force Centre, by telephoning:

08705 929 929

Help us to help you

Please determine your type of enquiry before telephoning. When you contact us we need to know:

1. Your name, address and post code.
2. Your telephone number.
3. Clear and concise details of the fault.
 - What is the fault?
 - When does the fault occur?
 - Does the multi-display issue an error-message (*E* and a number)?
4. The model, production number and production identification number.
5. Date of purchase.

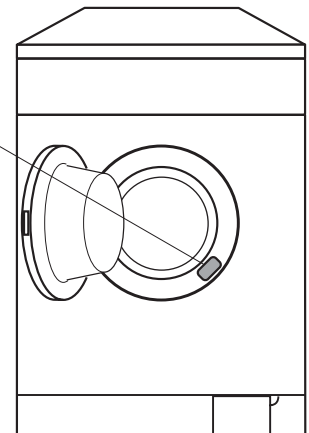
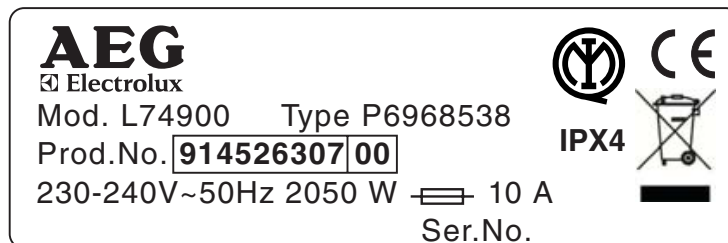

This information can be found on the rating plate, so you have these numbers to hand we recommend you write them below.

Prod. No.

Ser. No.

Customer care

For general enquiries regarding your AEG/ELECTROLUX appliance, or further information on AEG/ELECTROLUX products please contact our Customer Care Department at the address below or visit our website at: www.aeg-electrolux.co.uk

Customer Care Department
AEG/ELECTROLUX Major Appliances
Addington Way
Luton
Bedfordshire LU4 9QQ
Tel: 08705 350350*

*Calls to this number may be recorded for training purposes.

Guarantee Conditions

AEG/ELECTROLUX offer the following guarantee to the first purchaser of this appliance.

1. The guarantee is valid for 12 months commencing when the appliance is handed over to the first retail purchaser, which must be verified by purchase invoice or similar documentation.

The guarantee does not cover commercial use.

2. The guarantee covers all parts or components which fail due to faulty workmanship or faulty materials. The guarantee does not cover appliances where defects or poor performance are due to misuse, accidental damage, neglect, faulty installation, unauthorised modification or attempted repair, commercial use or failure to observe requirements and recommendations set out in the instruction book.

This guarantee does not cover such parts as light bulbs, removable glass-ware or plastic, dust bags or filters.

3. Should guarantee repairs be necessary the purchaser must inform the nearest customer service office (AEG/ELECTROLUX's service or authorised agent). AEG/ELECTROLUX reserves the right to stipulate the place of the repair (i. e. the customer's home, place of installation or AEG/ELECTROLUX workshop).
4. The guarantee or free replacement includes both labour and materials.
5. Repairs carried out under guarantee do not extend the guarantee period for the appliance. Parts removed during guarantee repairs become the property of AEG/ELECTROLUX.
6. The purchaser's statutory rights are not affected by this guarantee.

European Guarantee

If you should move to another country within Europe then your guarantee moves with you to your new home subject to the following qualifications:

- The guarantee starts from the date you first purchased your product.
- The guarantee is for the same period and to the same extent for labour and parts as exist in the new country of use for this brand or range of products.
- This guarantee relates to you and cannot be transferred to another user.
- Your new home is within the European Community (EC) or European Free Trade Area.
- The product is installed and used in accordance with our instructions and is only used domestically, i.e. a normal household.

- The product is installed taking into account regulations in your new country.

Before you move please contact your nearest Customer Care Centre, listed below, to give them details of your new home. They will then ensure that the local Service Organisation is aware of your move and able to look after you and your appliance.

France	Senlis	+33 (0) 44 62 29 29
Germany	Nürnberg	+49 (0) 911 323 2600
Italy	Pordenone	+39 (0) 167 8 47053
Sweden	Stockholm	+46 (0) 8 738 7910
UK	Luton	+44 (0)8705 350350

Instructions for installation and electrical connection



Safety instructions for the installer

- This appliance is heavy, care should be taken when moving it.
- When unpacking the appliance, check that it is not damaged. If in doubt, do not use it and contact the retailer.
- All internal packing must be removed before using the appliance. Serious damage may be caused to the machine or adjacent furniture if the protective transit devices are not completely removed. Refer to the relevant paragraph.
- Any electrical work required to install this appliance must be carried out by a qualified electrician.
- Any plumbing work required to install this appliance must be carried out by a qualified plumber.
- After having installed the machine, check that it is not standing on its electrical supply cable.
- If the appliance is placed on a carpeted floor, ensure that air can circulate freely between the adjustable feet and the floor.
- The installation should comply with local water authority and building regulations requirements.
- Should the appliance power supply cable need to be replaced, this should be carried out by our Service Force Centre.

Installation

Unpacking

⚠ All transit bolts and packing must be removed before using the appliance.

👉 After removing all the packaging, carefully lay machine on it's back to remove the polystyrene base from the bottom.

👉 Remove the power supply cable and the draining hose from the hose holders on the rear of the appliance.

👉 With a suitable spanner, supplied with the machine unscrew and remove the central rear bolt **A**. Slide out the relevant plastic spacer.

👉 Unscrew and remove the two large rear bolts **B** and the six smaller bolts **C**.

👉 Remove the bracket **D**. Tighten up the six smaller bolts **C**.

👉 Open the port-hole, take out the inlet hose from the drum and remove the polystyrene block fitted with the adhesive tape on the door seal.

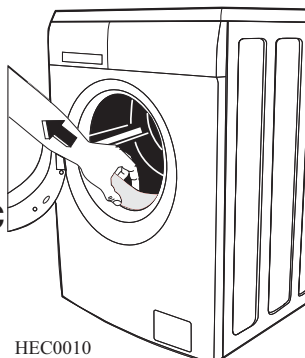
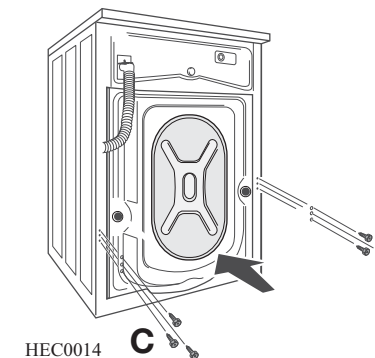
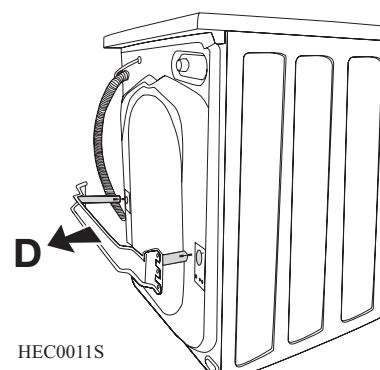
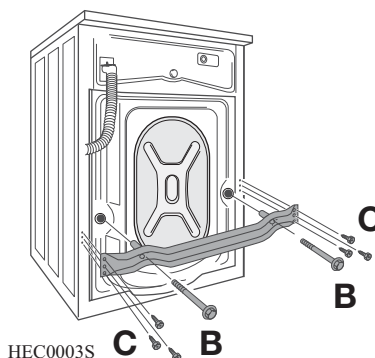
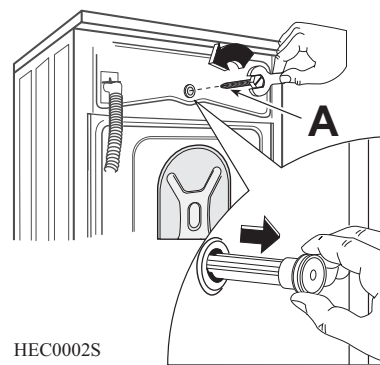
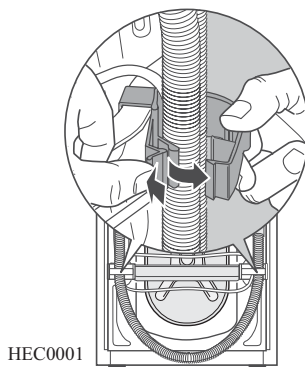
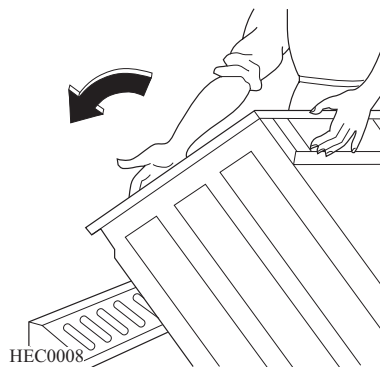

-  Fill the smaller upper hole and the two large ones with the corresponding plastic plug caps supplied in the bag containing the instruction booklet.

Important!

All the different plug caps are supplied with the appliance in the plastic bag containing the instruction booklet.

-  Connect the water inlet hose as described under the paragraph "Water inlet".

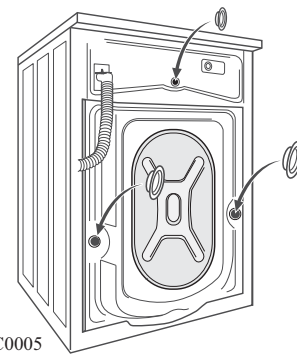

HEC0005

Positioning

Install the machine on a flat hard floor. Make sure that air circulation around the machine is not impeded by carpets, rugs etc.

- Before placing it on small tiles, apply a rubber coating.
- Never try to correct any unevenness in the floor by putting pieces of wood, cardboard or similar materials under the machine.
- If it is impossible to avoid positioning the machine next to a gas cooker or coal-burning stove, an insulating panel (85x57 cm) covered with aluminium foil on the side facing the cooker or stove, must be inserted between the two appliances;
- The machine must not be installed in rooms where the temperature can drop below 0.
- The water inlet hose and the drain hose must not be kinked.
- Please ensure that when the appliance is installed, it is easily accessible for the engineer in the event of a breakdown.

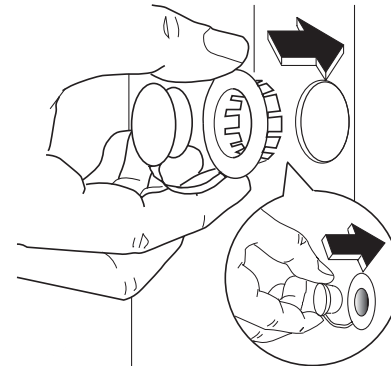

Levelling

Carefully level by screwing the adjustable feet in or out. Never place cardboard, wood or similar materials under the machine to compensate for any unevenness in the floor.

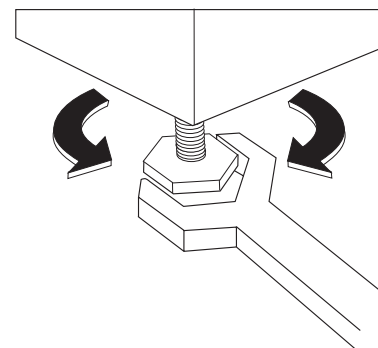

Water inlet

Attention!

- An inlet hose is supplied and can be found inside the machine drum.
- **Do not use the hose from your previous machine to connect to the water supply.**

• **This appliance must be connected to a cold water supply.**

1. Open the porthole and extract the inlet hose.
2. Connect the hose with the angled connection to the machine.

Important!

Do not place the inlet hose downwards. Angle the hose to the left or right depending on the position of your water tap.

3. Set the hose correctly by loosening the ring nut. After positioning the inlet hose, be sure to tighten the ring nut again to prevent leaks.

4. Connect the hose to a tap with a 3/4" thread.

Always use the hose supplied with the appliance.

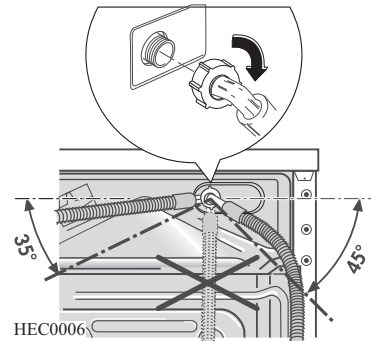

Installation should comply with local water authority and building regulations' requirements. A minimum water pressure of 0.05 MPa (0.5 bar) is required for safe operation of the appliance.

If you cannot make the cold water connection direct from the rising mains, you may be able to operate the appliance from your cold water storage system. There should be a minimum distance of 5.02m (16.5 ft) between the appliance's inlet and the bottom of the water storage tank.

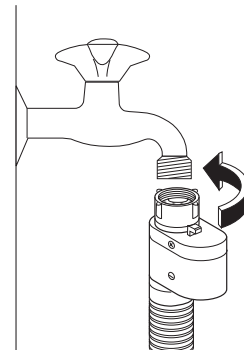

Aqua Stop

The inlet hose is provided with a water stop device, which protects against damage caused by water leaks in the hose which could develop due to natural ageing of the hose. This fault is shown by a red sector in the window „A“. Should this occur, turn the water tap off and refer to your Service Centre to replace the hose.

Water drainage

This appliance is designed to be permanently plumbed into your home's drainage system using one of the following methods.

1. Into a drainage standpipe.

Firstly form a hook in the end of the drain hose using the "U" piece" supplied.

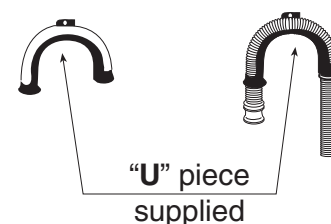

Place the drain hose into your standpipe, which should have an internal diameter of approximately 38mm thus ensuring there is an air break between the drain hose and standpipe.

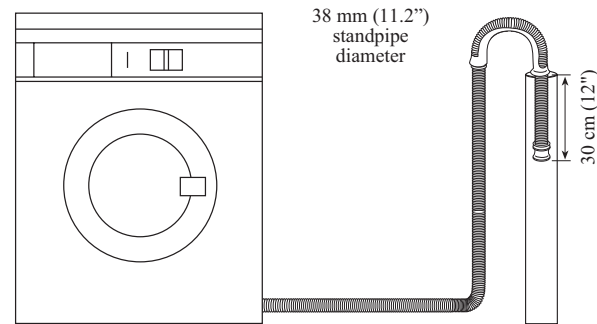

When discharging into a standpipe ensure that the top of the standpipe is no more than 90 cm (35.4") and no less than 60 cm (23.6") above floor level.

The drain hose may be extended to a maximum of 4 metres. An additional drain hose and joining piece is available from your local Service Force Centre. The joining piece must have an internal diameter of 18 mm.

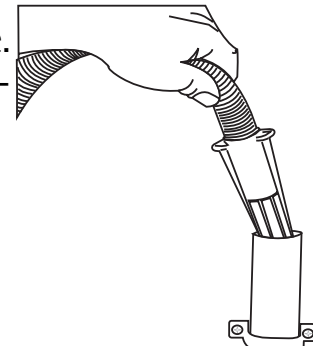
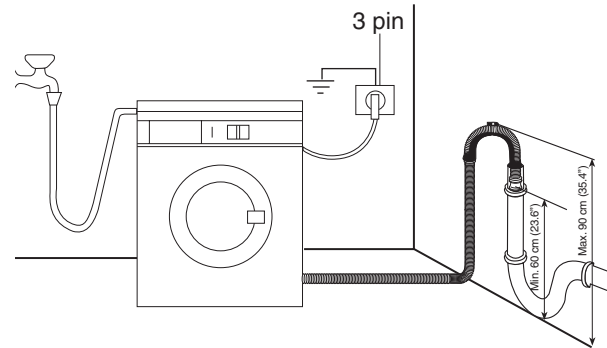

If your drain hose looks like this (see below) you do not require the "U" piece". Just push the hose firmly into the standpipe.

2. Onto a sink outlet spigot.

If the outlet spigot has not been used before, remove any blanking plug that may be in place.

Push the drain hose onto the spigot and secure with a clip if required, ensure a loop is formed in the drain hose (see diagram) to prevent waste from the sink entering the washing machine.

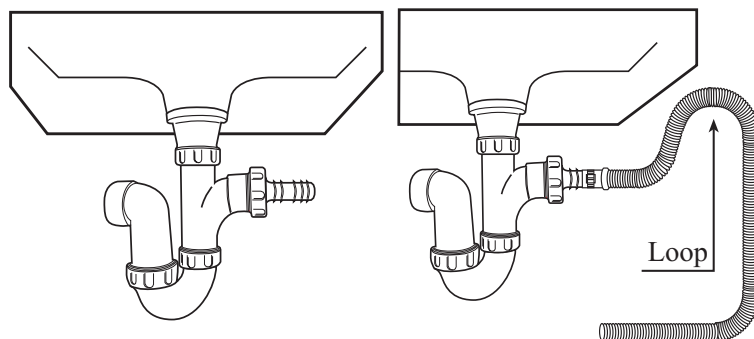

If you intend the drain hose from the machine to empty into a sink, make sure that the sink is empty and the plug hole is not blocked. Use the plastic "U -Piece" supplied.

Important

Before connecting up the machine to new pipework or to pipework that has not been used for some time, run off a reasonable amount of water to flush out any debris that may have collected in the pipes.

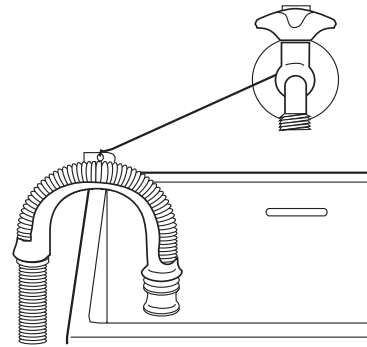

In the interest of the environment

Washing machines and dishwashers should be connected to the FOUL drainage system, the water will then be taken to a sewage works for treatment before being discharged safely into a river.

It is essential that these appliances are not connected to the surface water drainage system as this water is discharged directly into a river or stream and may cause pollution.

If you require any further advice please contact your local water authority.

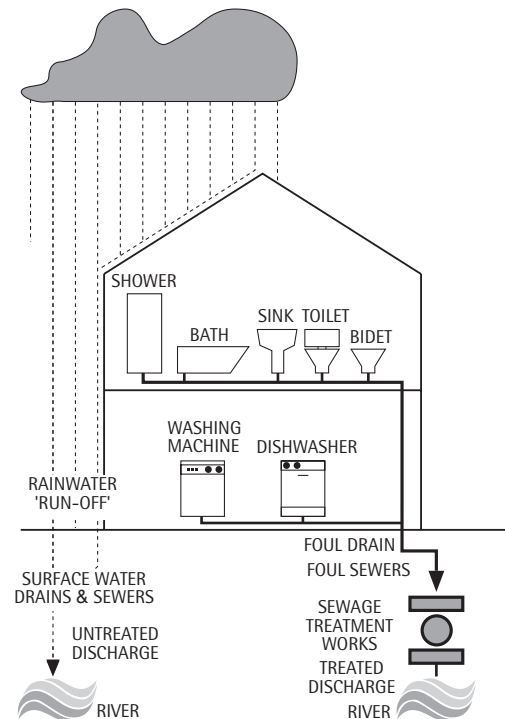

Electrical connection



WARNING: THIS APPLIANCE MUST BE EARTHED.

The manufacturer declines any liability should this safety measure not be observed.

If the plug that is fitted to your appliance is not suitable for your socket outlet, it must be cut off and the appropriate plug fitted.

Remove the fuse from the cut off plug.

The cut off plug should then be disposed of to prevent the hazard of shocks in case it should be plugged into a 13 Amp socket in another part of your home.

Important

The wires in the mains lead are coloured in accordance with the following code:

Green and Yellow	- Earth
Blue	- Neutral
Brown	- Live

If you fit your own plug, the colours of the wires in the mains lead of your appliance may not correspond with the markings identifying the terminals in your plug, proceed as follows:

Connect the green and yellow (earth) wire to the terminal in the plug which is marked with the letter «E» or the earth symbol \perp or coloured green and yellow.

Connect the blue (neutral) wire to the terminal in the plug which is marked with the letter «N» or coloured black.

Connect the brown (live) wire to the terminal in the plug which is marked with the letter «L» or coloured red.

The plug moulded on to the lead incorporates a fuse. For replacement, use a 13 Amp BS1362 fuse. Only ASTA or BSI approved fuses should be used.

The plug must not be used if the fuse cover/carrier is lost. The cover/carrier is indicated by the coloured insert at the base of the plug.

A replacement cover/carrier must be obtained from your local AEG/ELECTROLUX Service Centre.

Permanent connection

In the case of a permanent connection it is necessary that you install a double pole switch between the appliance and the electricity supply (mains), with a minimum gap of 3 mm between the switch contacts and of a type suitable for the required load in compliance with the current electrical regulations.

The switch must not break the yellow and green earth cable at any point.

This operation must be performed by a qualified electrician.

Important: The power supply cable must be easily accessible after installing the machine.

AEG/ELECTROLUX Hausgeräte GmbH
Postfach 1036
D-90327 Nürnberg

<http://www.aeg-electrolux.hausgeraete.de>

© Copyright by AEG/ELECTROLUX

132.978.470-01-02007 Subject to change without notice.



From the Electrolux Group. *The world's No. 1 choice.*

The Electrolux Group is the world's largest producer of powered appliances for kitchen, cleaning and outdoor use. More than 55 million Electrolux Group products (such as refrigerators, cookers, washing machines, vacuum cleaners, chain saws and lawn mowers) are sold each year to a value of approx. USD 14 billion in more than 150 countries around the world.